

## Inbouwconnector, Ø8mm snap

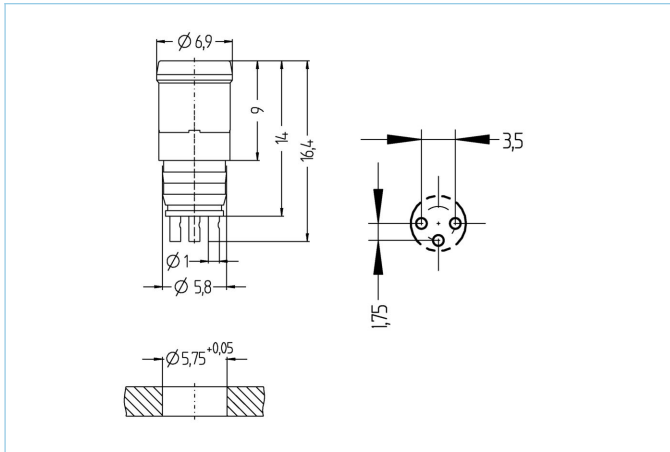

### Productinformatie

Artikelomschrijving	ESHP3L
Artikel-Nr.	8008161
BTW tarief nr.	85366990
Step File	ESHP3L.stp
EAN	4047106094072

### Technische gegevens

Connector	male, Ø8mm snap
Aantal polen	3
Nominale spanning	60V
Stroombelasting (bij 40°C)	4A
Isolatiweerstand	$\geq 10^9 \Omega$
Omgevingstemperatuur	-30°C...+90°C
Contact materiaal	Metaal, CuZn, verguld
Materiaal contactdrager	Kunststof, PA, transparant
Soort aansluiting	Soldeercontact
Normen	IEC 61076-2-104
Afdichting (aangesloten)	IP65, IP67
Mechanische levensduur	>100 steekcycli
Vervuilingsgraad	3/2

### Classificaties

eCl@ss 6.0	27279220
eCl@ss 7.0	27440103
eCl@ss 8.0	27440103
eCl@ss 9.0	27440103
ETIM 5.0	EC002061
ETIM 6.0	EC002061