

Y-splitter, M8, with cable outlet

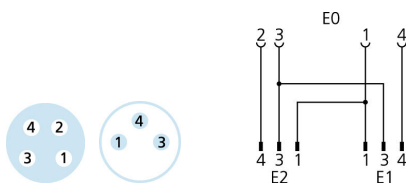
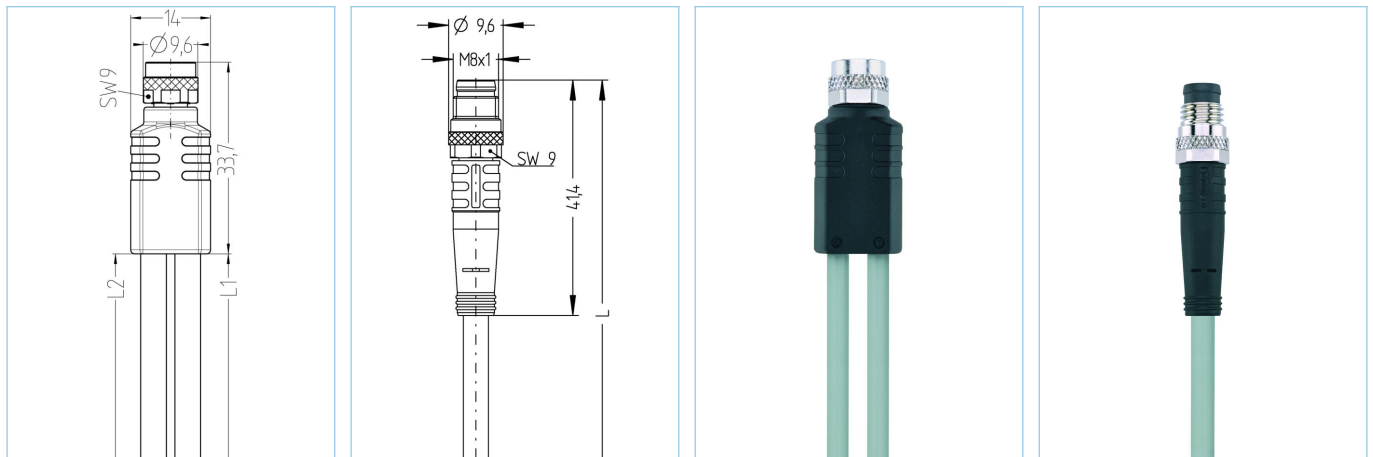

Product data

Item description	YK-FK4M8-2AL-SSP3-1/1/P00
Item-No.	8075931
Length	1m
Customs tariff-No.	85444290
Step-File	YK-FK4M8_2AL-SSP3-L_L.stp
EAN	4047106170493

	Exit 0	Exit 1	Exit 2
Connector	female, M8, straight	male, M8, straight	male, M8, straight
Contact material	Metal, CuZn, gold-plated	Metal, CuSn, gold-plated	Metal, CuSn, gold-plated
Contact-carrier material	Plastic, TPU, BK	Plastic, TPU, BK	Plastic, TPU, BK
Coupling nut material	Metal, CuZn, nickel-plated	Metal, CuZn, nickel-plated	Metal, CuZn, nickel-plated
Rated voltage	60V	60V	60V
Coding of	A	A	A
Number of pins	4	3	3
Current load (at 40°C)	4A	4A	4A

Insulation resistance $\geq 10^9 \Omega$

Ambient temperature product $-30^\circ\text{C} \dots +90^\circ\text{C}$

Grip body material Plastic, TPU, BK

Sealing (female) material FPM/FKM

Mechanical life-cycle >100 mating cycles

Standards IEC 61076-2-104

Degree of protection (mounted) IP65, IP67, IP68

Degree of pollution 3

Cable	PVC, P00, GY
PVC-cable for measurement and control-, and sensor technology. Suitable for applications in dry areas on packaging machines, assembly- and conveyor technology. High flexibility with unstressed movement (conditional drag-chain application possible). Predestined for applications in food- and beverage industry.	
Outer diameter of jacket	4,00 mm
Cable-jacket material	PVC
Jacket color	GY, similar RAL7040
Wire cross-section	3 x 0.25 mm ²
Wire insulation material	PVC
Wire colors	BN, BU, BK
Conductor structure	14 x 0.15 mm
Bending radius (fixed)	5 x Ø-cable
Bending radius (repeated)	10 x Ø-cable
Temperature range (repeated)	0°C...+80°C
Temperature range (fixed)	-25°C...+80°C
Rated voltage cable	≤300 V
Special features	seawater resistant, recyclable, LABS free, RoHs compliant, acid- and alkali resistant, ozone resistant, UV resistant
Classification	
eCl@ss 6.0	27279218
eCl@ss 7.0	27279218
eCl@ss 8.0	27279218
eCl@ss 9.0	27060313
ETIM 5.0	EC001855
ETIM 6.0	EC001855