

Panel connector, Ø8mm snap

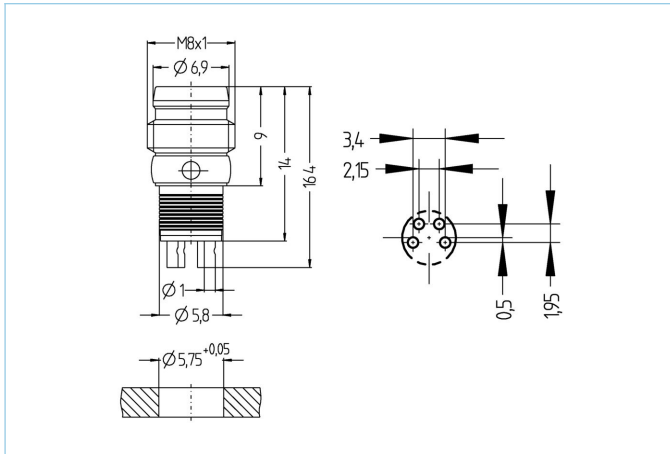

Product data

Item description	ESGP4L
Item-No.	8008745
Customs tariff-No.	85366990
Step-File	ESGP4L.stp
EAN	4047106091675

Technical data

Connector	male, M8/Ø8mm snap
Number of pins	4
Rated voltage	60V
Current load (at 40°C)	4A
Insulation resistance	≥10 ⁹ Ω
Ambient temperature product	-30°C...+90°C
Contact material	Metal, CuZn, gold-plated
Housing material	Metal, CuZn, nickel-plated
Connecting type	Soldering contact
Standards	IEC 61076-2-104
Degree of protection (mounted)	IP65, IP67
Mechanical life-cycle	>100 mating cycles
Degree of pollution	3/2

Classification

eCl@ss 6.0	27279220
eCl@ss 7.0	27440103
eCl@ss 8.0	27440103
eCl@ss 9.0	27440103
ETIM 5.0	EC002061
ETIM 6.0	EC002061