

Y-splitter, M12, with cable outlet

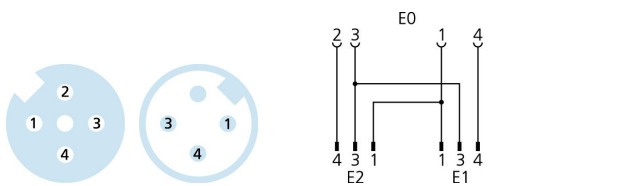
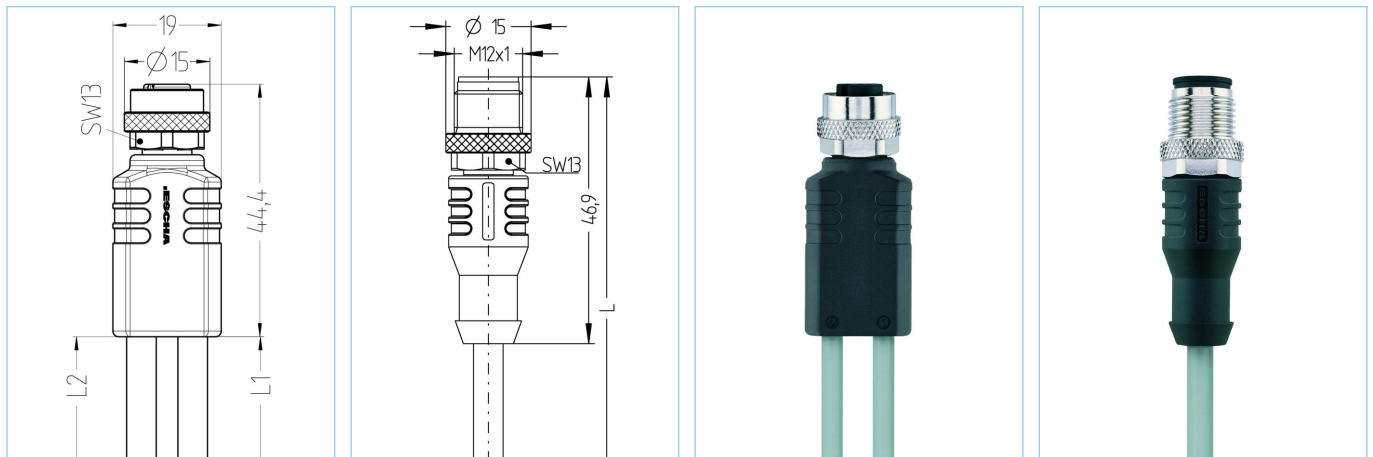

Product data

Item description	YK-FK4M12-2AL-WAS3-0,6/0,6/P00
Item-No.	8076005
Length	0.6m
Customs tariff-No.	85444290
Step-File	YK-FK4M12-2AL-WAS3-L_L.stp
EAN	4047106174262

	Exit 0	Exit 1	Exit 2
Connector	female, M12, straight	male, M12, straight	male, M12, straight
Contact material	Metal, CuZn, gold-plated	Metal, CuSn, gold-plated	Metal, CuSn, gold-plated
Contact-carrier material	Plastic, TPU, BK	Plastic, TPU, BK	Plastic, TPU, BK
Coupling nut material	Metal, CuZn, nickel-plated	Metal, CuZn, nickel-plated	Metal, CuZn, nickel-plated
Rated voltage	60V	250V	250V
Coding of	A	A	A
Number of pins	4	3	3
Current load (at 40°C)	4A	4A	4A

Insulation resistance	$\geq 10^9 \Omega$
Ambient temperature product	-30°C...+90°C
Grip body material	Plastic, TPU, BK
Sealing (female) material	FPM/FKM
Mechanical life-cycle	>100 mating cycles
Standards	IEC 61076-2-101
Degree of protection (mounted)	IP65, IP67, IP68
Degree of pollution	3

Cable	PVC, P00, GY
PVC-cable for measurement and control-, and sensor technology. Suitable for applications in dry areas on packaging machines, assembly- and conveyor technology. High flexibility with unstressed movement (conditional drag-chain application possible). Predestined for applications in food- and beverage industry.	
Outer diameter of jacket	4,20 mm
Cable-jacket material	PVC
Jacket color	GY, similar RAL7040
Wire cross-section	3 x 0.34 mm ²
Wire insulation material	PVC
Wire colors	BN, BU, BK
Conductor structure	19 x 0.15 mm
Bending radius (fixed)	5 x Ø-cable
Bending radius (repeated)	10 x Ø-cable
Temperature range (repeated)	0°C...+80°C
Temperature range (fixed)	-25°C...+80°C
Rated voltage cable	≤300 V
Special features	seawater resistant, recyclable, LABS free, RoHs compliant, acid- and alkali resistant, ozone resistant, UV resistant
Classification	
eCl@ss 6.0	27279218
eCl@ss 7.0	27279218
eCl@ss 8.0	27279218
eCl@ss 9.0	27060313
ETIM 5.0	EC001855
ETIM 6.0	EC001855