

Double-ended cordset, 100 MBit/s, Industrial Ethernet, RJ45, shielded

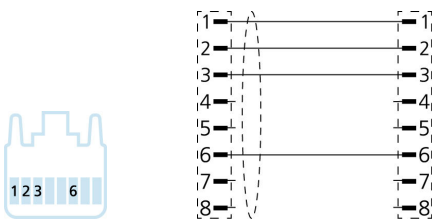
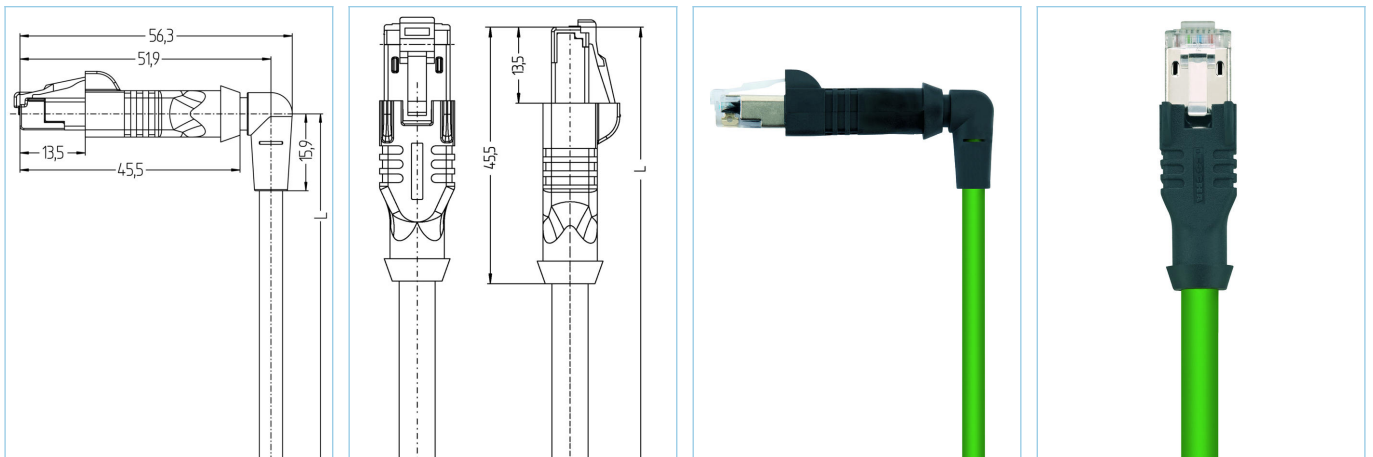

Product data	
Item description	IE-W0RJ45SS8.005-1-IE-RJ45SS8.005/S3400
Item-No.	8080803
Length	1m
Customs tariff-No.	85444290
Step-File	IE-W0RJ45SS8-m-IE-RJ45SS8.stp
EAN	4047106231651
Label-carrier	without Label-carrier

Technical data	A-side	B-side
Connector	male, angled, RJ45, 0°	male, straight, RJ45
Number of pins	4	4
Pin assignment	1 WH/OG, 2 OG, 3 WH/BU, 6 BU	1 WH/OG, 2 OG, 3 WH/BU, 6 BU
Allocation	Industrial	Industrial
Rated voltage	50V	50V
Current load (at 40°C)	1A	1A
Insulation resistance	≥10 ⁸ Ω	≥10 ⁸ Ω
Transmission features	Cat5e	Cat5e
Ambient temperature product	-40°C...+70°C	-40°C...+70°C
Contact material	Metal, CuZn, gold-plated	Metal, CuZn, gold-plated
Contact-carrier material	Plastic	Plastic
Grip body material	Plastic, TPE, BK	Plastic, TPE, BK
Shielding	with shielding	with shielding
Material of shielding housing	Metal, CuZn, nickel-plated	Metal, CuZn, nickel-plated
Standards	IEC 60603-7-5	IEC 60603-7-5
Degree of protection (mounted)	IP20	IP20
Mechanical life-cycle	>1000 mating cycles	>1000 mating cycles
Degree of pollution	1	1

Advanced technical data UL

Rated voltage	30V _{AC/DC}
Rated current	1,0A

cable Cat5e, PUR, UL, S3400

Shielded PUR Ethernet-cable for industrial applications. Fits to real-time requirements according to IEC61158. The cable meets the UL-Style20963 (80°/30V)- and the Cat5 (electrical properties according to EN50288-2-2) requirements. Materials and a constructive setup for increased mechanical stresses (abrasion, bending, vibrations etc.) of the cable. Drag-chain/torsion operations are possible. High tensile strength through incorporated Kevlar-strands.

Outer diameter of jacket	4,80 mm
Cable-jacket material	PUR
Jacket color	GN, similar RAL6018
Wire cross-section	1 x 4 x AWG26, star quad
Wire insulation material	PP
Wire colors	BU, OG, WH/BU, WH/OG
Conductor structure	19 x 0.10 mm
Bending radius (fixed)	4 x Ø-cable
Bending radius (repeated)	7,5 x Ø-cable
Temperature range (fixed)	-40°C...+80°C
Transmission features	Cat5
Rated voltage cable	30 V UL rating
Special features	seawater resistant, recyclable, LABS free, RoHs compliant, acid- and alkali resistant, ozone resistant, UV resistant, hydrolysis proof, drag chain-adapted, halogen free, oil resistant, high flexibility, microbes resistant

Classification

eCl@ss 6.0	27060307
eCl@ss 7.0	27060307
eCl@ss 8.0	27060307
eCl@ss 9.0	27060307
ETIM 5.0	EC002599
ETIM 6.0	EC002599

Accessories

Unlocking clip for RJ45	https://www.escha.net/en/products/accessoires/unlocking-clips-for-rj45/
-------------------------	---