

**Your Advantages**

- Suitable for DC charging stations for electric vehicles acc. to IEC/EN 61851-23
- Insulation monitoring according to IEC/EN 61557-8
- With connection facility of an external coupling device RL 5898 for voltages up to AC 400 V / DC 500 V or RP 5898 for voltages up to AC 690 V / DC 1000 V
- Very fast reaction time  $\leq 1$  s
- Optimised insulation resistance monitoring also during mains voltage variation
- Self-test every full operating hours
- Preventive fire and system protection
- Detection of symmetric and asymmetric insulation faults
- Quick fault localisation through selective earth fault detection to L+ and L-
- Universal application in non-earthed AC, DC, AC/DC networks up to AC max. 250 V or DC max. 300 V
- Easy adjustment of response values and setting parameter via rotational switch and menu display
- Suitable for large leakage capacitances up to 5  $\mu$ F
- Monitoring also with voltage-free mains
- Measuring circuit L(+)/L(-) with broken wire detection (can be switched off)
- Protective conductor PE1/PE2 with broken wire detection (can't be switched off)

**Product Description**

The insulation monitor RN 5897/020 of the VARIMETER IMD family provides best and up to date insulation monitoring of modern IT systems in an optimum and state of the art way fulfilling the relevant standards. The device can be used in the most flexible way for AC, DC and AC/DC systems. Mains areas of applications are non-earthed DC charging stations for electric vehicles with mains voltages up to DC 1000 V. The adjustment of the setting values is simple and user friendly done on 2 rotary switches on the front of the device. Via display and LEDs the measured value, device parameters and device status are indicated easy to read. With a sealable transparent cover the device is protected against manipulation.

**Function Diagram**

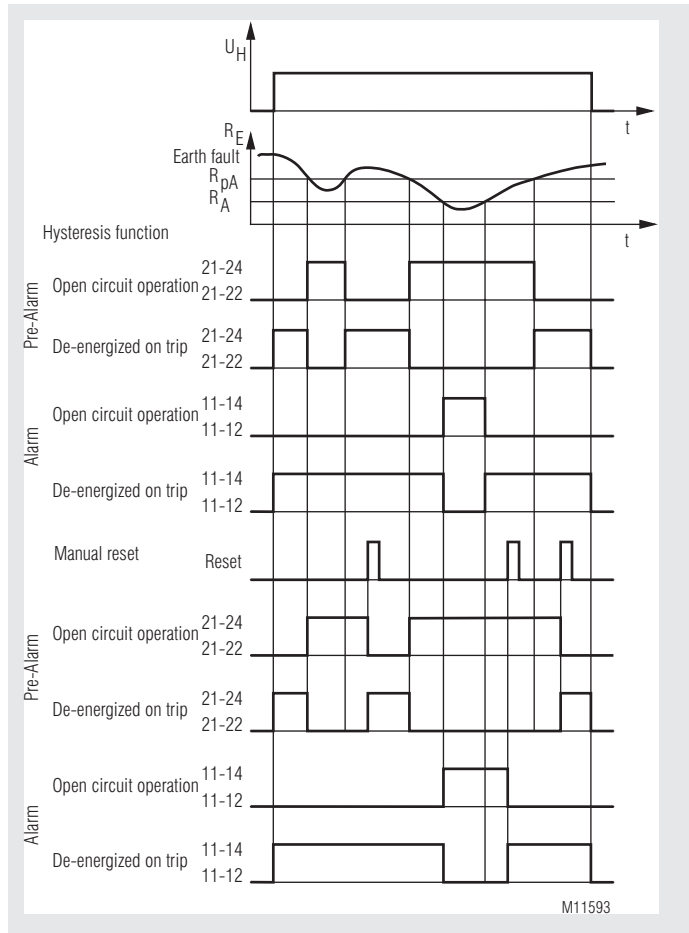

**Features**

- 2 separate adjustable response thresholds (using e.g. for pre-alarm and Alarm)
- Setting range of 1st response value (Pre-alarm): 20 k $\Omega$  ... 500 k $\Omega$
- Setting range of 2nd response value (alarm): 1 k $\Omega$  ... 100 k $\Omega$
- 1 changeover contacts each for insulation failures-Pre-alarm and -alarm
- Energized or de-energized on trip can be selected for indicator relay
- Display for indication of measured value, device parameters and device status
- Automatic and manual device self-test
- Alarm storage selectable
- Protection against manipulation by sealable transparent cover
- External control input for combined test- / reset-button with additional Stop of the measuring function
- 3 wide voltage input for auxiliary voltage
- Width 52.5 mm

**Approvals and Markings**



**Applications**

- Insulation monitoring of:
- Non-earthed AC, DC, AC/DC networks
  - DC charging stations for electric vehicles
  - UPS systems
  - Networks with frequency inverters
  - Battery networks
  - Networks with direct current drives
  - Hybrid and battery-powered vehicles
  - Mobile generator sets

## Function

The device is supplied with DC auxiliary voltage via terminals A1(+) / A2. Switching on the auxiliary voltage (Power-On) is followed by an internal self-test for 10 s (see „Device test functions“). The test process is visible in the display. After this, measurement of the insulation resistance in the measuring circuits begins and the colour of the backlight changes into green.

### Measuring circuit

#### (Insulation measurement between terminals L(+)/L(-) and PE1/PE2)

The insulation monitor RN 5897/020 can be operated either with or without coupling device. Max. mains voltage and connection diagrams have to be observed!

If the insulation monitor is operated without coupling device the terminals L(+) and L(-) have to be connected directly to the voltage system to be monitored. and the terminals VSG1/L(+) and VSG2/L(-) each have to be bridged (see also operation with coupling device).

A broken wire detection that can be disabled provides a fault signal if both terminals L(+) and L(-) are not linked by the connected network.

The type of network (AC, DC, 3NAC) has to be selected.

Also the terminals PE1 and PE2 have to be connected with 2 separate wires to the protective earth. An interruption of a wire also causes a fault signal (see section "Behavior on faulty connection"). The monitoring of the PE connection cannot be de-activated.

To measure the insulation resistance an active measuring voltage with changing polarity is connected between L(+)/L(-) and PE1/PE2. The momentary polarity of the measuring cycle is shown on the display by 2 cursor segments („MP+“ for positive phase and „MP-“ for negative phase). The duration of the positive and negative measuring phase depends on the actual leakage capacity of the monitored system and in DC systems also on the level and duration of possible voltage variations. This allows a correct and fast measurement in different network conditions.

At the end of a measuring cycle the actual insulation resistance is produced and indicated. The actual value is shown on the display. The relays for alarm K1 and pre-alarm K2 switch when dropping under the adjusted response values. In addition the backlight of the display changes to orange color on pre-alarm or to red color on alarm. An asymmetric earth fault either to „+“ or „-“ is also indicated on the display (only in DC- systems or with a fault on the DC-side of a system).

### Manual reset of fault message

Using the display menu in programming mode, the manual reset function for insulation failures can be selected. If manual reset is activated the insulation fault signals of the measuring circuit are stored when dropping under the adjusted response values also if the insulation resistance goes back to healthy state. The minimum value is stored and can be shown on the display. Pressing the „Reset“ button on the front side for 2 s, the alarm signal and the stored minimum value are reset if the actual insulation resistance is in healthy state.

### Indicator relay for insulation fault signal

For the indicator relays K1 (contacts 11-12-14, for alarm) and K2 (contacts 21-22-24, for pre-alarm) the function can be set in programming mode to energized on trip or de-energized on trip when the insulation resistance drops below the adjusted response value.

The status of the indicator relays is shown on the display with the two cursor segments "K1" and "K2". When the relay is energized, the corresponding cursor lights up.

### Disable the measuring function

Using the external control input X1/X2 the measuring function of the RN 5897/020 can be disabled. This could be used when several isolated voltage systems with individual insulation monitors need to be coupled. The measuring voltage is set to -90V (negative measuring phase) and the evaluation of the measurement is stopped. The status of the output relays is frozen and not changed any more. If the measurement is disabled the colour of the display changes to orange and the text "Stop!" is displayed. Please be aware, only the evaluation of the measurement is stopped and the measuring pulse is interrupted! A high resistive disconnection to PE does not take place (see internal resistance).

## Function

### Broken wire detection

As described in section "Measuring circuit", the measuring circuits L(+)/L(-) and the protective conductors PE1/PE2 are constantly monitored for wire breaks – not only at Power-On or a manual or occasional automatic test. The response time of monitoring is only a few seconds. Broken wire detection between L(+) and L(-) is performed via coupled alternating voltage. This alternating voltage is short-circuited if the terminals are connected to the connected mains at low-resistance. The device detects that the mains to be monitored is properly connected.

Since this broken wire detection is carried out with alternating voltage, large capacitances should be avoided between L(+) and L(-), since the capacitive reactance of these capacitances also short-circuits this alternating voltage.

The device would no longer detect a connection fault on L(+)/L(-).

Especially parallel lines should be prevented over larger distances.

If larger capacitances between L(+)/L(-) cannot be avoided or if the coupled alternating voltage interferes with the system, the broken wire detection can be de-activated using the display menu in programming mode. Monitoring deactivated, monitoring only during device test or continuous monitoring (every 2 minutes for 10 s) are the possible options. If the broken wire detection on L(+)/L(-) is de-activated no AC voltage is injected. The broken wire detection on PE1/PE2 cannot be de-activated.

### Device test functions

Principally, 2 different test functions are implemented: The "self-test" and the "expanded test":

The self-test of the device is performed automatically after Power-On and every full operating hours. It can also be triggered manually at any time by pressing the "Test" button at the device front for 2 s.

With the self-test, contrary to the expanded test, the status of the Indicator relays is not affected; the sequence is as follows:

The display backlight colour changes into orange. For approx. 2 s all pixels and segments of the LCD are shown. After that the text "Test1" comes up and the measuring pulse is switched for approx. 4 s to negative test phase. The polarity of the test voltage is also indicated on the display by cursor segments. Within these 4 s the internal measuring circuit is checked for failures. Then the measuring pulse is switched for approx. 4 s to positive test phase and more internal tests take place. If no failures turned up and had been recognized, the measurement continuous. The extended test procedure is started when during or at the end of the above described self-test the test button is pressed again for 2 s.

The sequence is similar to the self-test (2 measuring phases of 4 s each) but in addition the output relays go in alarm state. The display shows "Test2". The test phases of the extended test will be repeated continuously. Pressing the reset button again for 2 s will stop the extended test immediately. The device starts the insulation measurement again.

### Behaviour with internal device faults

If internal device faults were detected during the test function, the display backlight changes into red and an error messages (failure code: „Int.1“) is indicated. The indicator relays K1 and K2 switch to the alarm state.

### Behavior on faulty connection

When detecting broken wire on terminals L(+)/L(-), the measurement is disabled. The reaction time could be up to 2 min. The monitoring relays K1 and K2 go in alarm state, the backlight changes to red. The display shows the fault message „L+/L-“. After removing the interruption the fault is automatically reset (max. reaction time up to 2 min) and the measurement of the insulation resistance is continued.

Stored alarm values remain stored. An interruption of the protective earth connections PE1/PE2 causes the same reaction as interrupting the measuring circuit, only the display shows „PE1-PE2“.

## Function

### External control input

To terminals X1/X2 an external combined Test-/Reset button can be connected. If the terminals X1/X2 are bridged for approx. > 1,5 s and < 10 s the test mode is started. This has the same function as pressing the internal test button. When bridging X1/X2 for < 1,5 s, a stored alarm will be reset. This has the same function as pressing the internal reset button.

If X1/X2 is activated for > 10 s, the measuring function is stopped.

The measuring function remains suspended for the duration of the control of X1/X2.

### Connection of an external coupling device

An external coupling device RL 5898 oder RP 5898 can be connected to extend the input voltage range of the monitored voltage system on RN 5897/020. The terminals with the same legend of the insulation monitor and the coupling device (VSG1, VSG2, L(+), L(-)) are connected together. The network to be monitored is connected to terminals L1(+) und L2(-) on the coupling device. Using the display menu in programming mode the connection of the coupling device has to be selected and activated. The broken wire detection is active on the terminals L1(+)/L2(-) on the coupling device. A broken wire between coupling device and insulation monitor cannot be detected immediately but the measured values on interruption of 1 or 2 wires between coupling device and insulation monitor are much lower as the real values, which will cause an early response of the device.

### Programming/setting of parameters/set-up of the insulation monitor

The response values for alarm and pre-alarm can be adjusted via 2 rotary switches „R<sub>A</sub>“ and „R<sub>pA</sub>“ on the front of the device. New settings are immediately active and do not require a restart of the unit. More settings can be done with the 3 buttons and the display menu in programming mode. To start the programming mode, the button „Set/ESC“ has to be pressed for approx. 2 s. To avoid unauthorized manipulation, this button as well as the rotary switches „R<sub>A</sub>“ and „R<sub>pA</sub>“ are located behind a sealable transparent cover. When the device changes to programming mode, the measurement is stopped, the display back light changes to orange color and the first parameter is displayed. To scroll the different parameters, the button „Set/ESC“ has to be pressed short. With the 2 scroll buttons (Scroll-Up „▲“ and Scroll-Down „▼“) the settings can be modified.

The first parameter is the broken wire detection in the measuring circuit „BrWiD“. Possible setting are continuously on („on“), continuously off („oFF“) or only active during self-test. The default is „on“.

The second parameter is alarm memory „Mem.“. Here are 2 options available manual reset („on“) und auto reset („oFF“). The default value is „oFF“. The third parameter is the relay operation principle „Rel.“ Settings are: de-energized on trip („n.c.“) and energized on trip („n.o.“). The default value is „n.c.“.

The fourth parameter is the type of network connection „Net“. Selection are AC Network („Ac“), DC-Network („dc“) or 3NAC-Network („3nAc“). The default value is „Ac“.

The device allow the connection of a coupling device, the fifth parameter activates („on“) or de-activates („oFF“) the coupling device.

The leave the programming mode the button „Set/ESC“ has to be pressed for 2 s. The settings will be activated and stored permanently. After that the device makes a restart similar to power on.

## Default-Setting of Parameters

Nr.	Parameter	Default-Set
1	Broken wire detect in measuring circuit "Broken Wire Detect"	on
2	Storing insulation fault message "Memory"	off
3	Switching mode of output relays "Relay"	n.c. (normally closed) de-energized on trip
4	Power supply type "Net"	AC
5	Ext. coupling device "VSG"	off

## Circuit Diagram

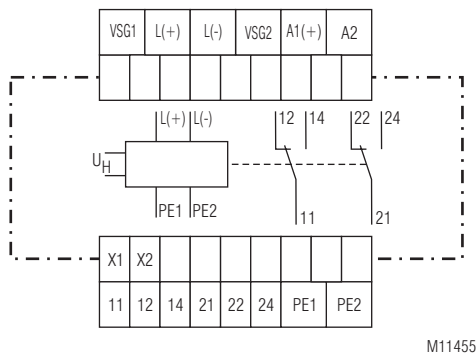

## Connection Terminals

Terminal designation	Signal description
A1(+), A2	Auxiliary voltage AC or DC
L(+), L(-), VSG1, VSG2	Connection for measuring circuit or Connection for coupling device
PE1, PE2	Connection for protective conductor
X1, X2	Control input (combined external Test- and Reset-input with additional Stop of the measuring function)
11, 12, 13	Alarm signal relay K1 (1 changeover contact)
21, 22, 23	Prewarning signal relay K2 (1 changeover contact)

## Indicators

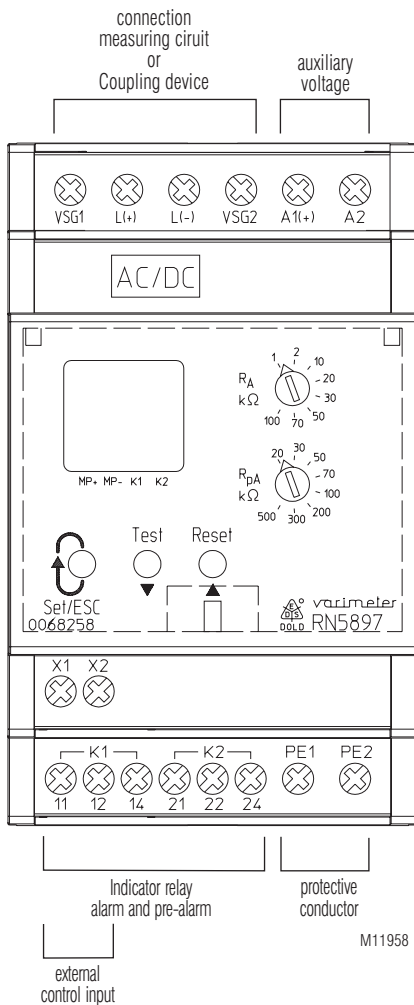

RN 5897/020

## Indicators

The colour of the backlight indicates the operating status of the device.





- Off:** No auxiliary voltage connected
- Green:** Normal operation (Insulation resistance in healthy state)
- Red:** Alarm (measured value below alarm response value, device failure, connection failure)
- Orange:** Warning (measured value below pre-alarm response value, test mode, Parameter set-up mode)



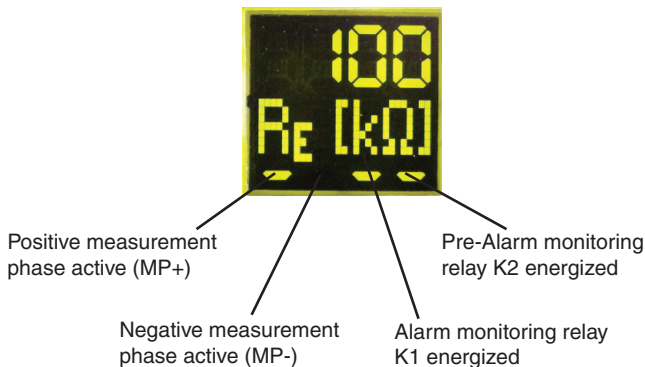

### Actual value display



The actual insulation resistance „ $R_E$  [k $\Omega$ ]“ is displayed. If the actual value is  $R_E < 10$  k $\Omega$ , the value in k $\Omega$  is displayed with 1 decimal place. With values  $10$  k $\Omega \leq R_E < 500$  k $\Omega$  the display shows the value without decimal place, with values  $500$  k $\Omega \leq R_E < 1$  M $\Omega$  the value is rounded to 10 k $\Omega$ . Insulation resistance values  $1$  M $\Omega \leq R_E < 2$  M $\Omega$  are displayed in M $\Omega$  with one decimal place. If the resistance is  $R_E > 2$  M $\Omega$  the display indicates ---- showing the value is higher the 2 M $\Omega$ . In a DC Network an asymmetric insulation resistance to „+“ or „-“ is indicated by displaying „ $R_{E+}$  [k $\Omega$ ]“ or „ $R_{E-}$  [k $\Omega$ ]“

By pressing the scroll buttons (Scroll-Up „▲“ und Scroll-Down „▼“) more measured values can be shown. Another value is the mains voltage on L(+)/L(-). This is indicated with „ $U_N$  [V $_{AC}$ ]“ or „ $U_N$  [V $_{DC}$ ]“ in V depending on the type of network and voltage. If the unit is connected single pole to a 3NAC network the mains voltage cannot be measured. With this setting the voltage value is not displayed. When manual reset is selected, the display shows the minimum stored value of the resistance „ $R_M$  [M $\Omega$ ]“ or „ $R_M$  [k $\Omega$ ]“ after the value dropped below the response value also when the value goes back to healthy state. The stored minimum value will only be reset when acknowledging the stored Alarm signal (with the reset button). Also the firmware version can be displayed.



Indicators	
Display-Indication	Measuring- resp. display value
	Insulating resistance in kΩ resp. MΩ („----“ complies RE ≥ 2 MΩ)
	Asymmetrical insulating resistance in kΩ against L+ or L- at DC-mains
	Measured mains voltage in V at AC- or DC-mains („----“ indicates invalid voltage value or voltage < 5 V)
	Stored min. insulating resistance in kΩ resp. MΩ
	Latest firmware-version

Error Indication		
Display-Indication	Failure cause	Failure recovery
	Broken wire detection on L(+)/L(-).	Check measuring circuit L(+) and L (-)
	Broken wire detection on PE1/PE2.	Check protective conductor connections PE1 and PE2
	Internal failure detected in test mode	Press test button again or restart the unit by interrupting the auxiliary supply temporarily. If the fault remains permanent, send device back to manufacturer for examination.
	Faulty calibration values detected in device memory.	Send device back to manufacturer for recalibration and examination.

Display-Indication	Test function
	Display-Test
	Selftesting (measuring switching, measuring voltage, internal tests)
	Advanced Test (additional control of indicator relay)

Display-Indication	Function
	Measuring function stopped

**Risk of electrocution!****Danger to life or risk of serious injuries.**

- Disconnect the system and device from the power supply and ensure they remain disconnected during electrical installation.
- The display of the voltage is not in real time. The Value on the display is updated at the end of a measuring cycle.
- Determine voltage free status by using appropriate instruments
- The terminals of the control input X1-X2 have no galvanic separation to the measuring circuit L(+) and L(-) and are electrically connected together, therefore they have to be controlled by volt free contacts or bridge. These contacts ore bridges must provide a sufficient separation depending on the mains voltage on L(+)-L(-).
- Please do not connect external voltage to terminals X1/X2. The control must only be made by bridging X1 and X2.
- The coupling unit RL 5898 or RP 5898 must only be used in conjunction with the RP5897/020 on a voltage system and not just by itself.

**Attention!**

- Before checking insulation and voltage, disconnect the monitoring device RN 5897/020 from the power source!
- In one voltage system only one insulation monitor can be used. This has to be observed when interconnecting two separate systems..
- Device terminals PE1 and PE2 must always be connected via separate lines to different terminal points of the protective-conductor system.
- The device must not be operated without PE1/PE2 connection!

**Attention!**

- The main measuring circuit can be connected with its terminals L(+) and L(-) both to the DC and also AC side of a mixed network; it is done most practically where the primary incoming power supply takes place e.g. with battery networks with connected inverters on the DC side, with Generators/Transformers with connected Rectifiers or inverters on the AC-side. To monitor a 3NAC system the device can be connected single pole, (L(+) and L(-) are bridged, to the neutral of the 3p4w system. The 3 phases have a low- $\Omega$ ic (approx. 3 – 5  $\Omega$ ) connection via the transformer windings so also insulation failures of the not directly connected phases are detected. Via the display menu in programming mode the correct type of network needs to be selected (see „Connection Examples“).
- If a monitored AC system includes galvanically connected DC circuits (e.g. via a rectifier), an insulation failure on the DC side can only be detected correctly, when a current of min 10 mA can flow via the semi-conductor connections.
- If a monitored DC system includes galvanically connected AC circuits (e.g. via an inverter), an insulation failure on the AC side can only be detected correctly, when a current of min 10 mA can flow via the semi-conductor connections.

Running chart

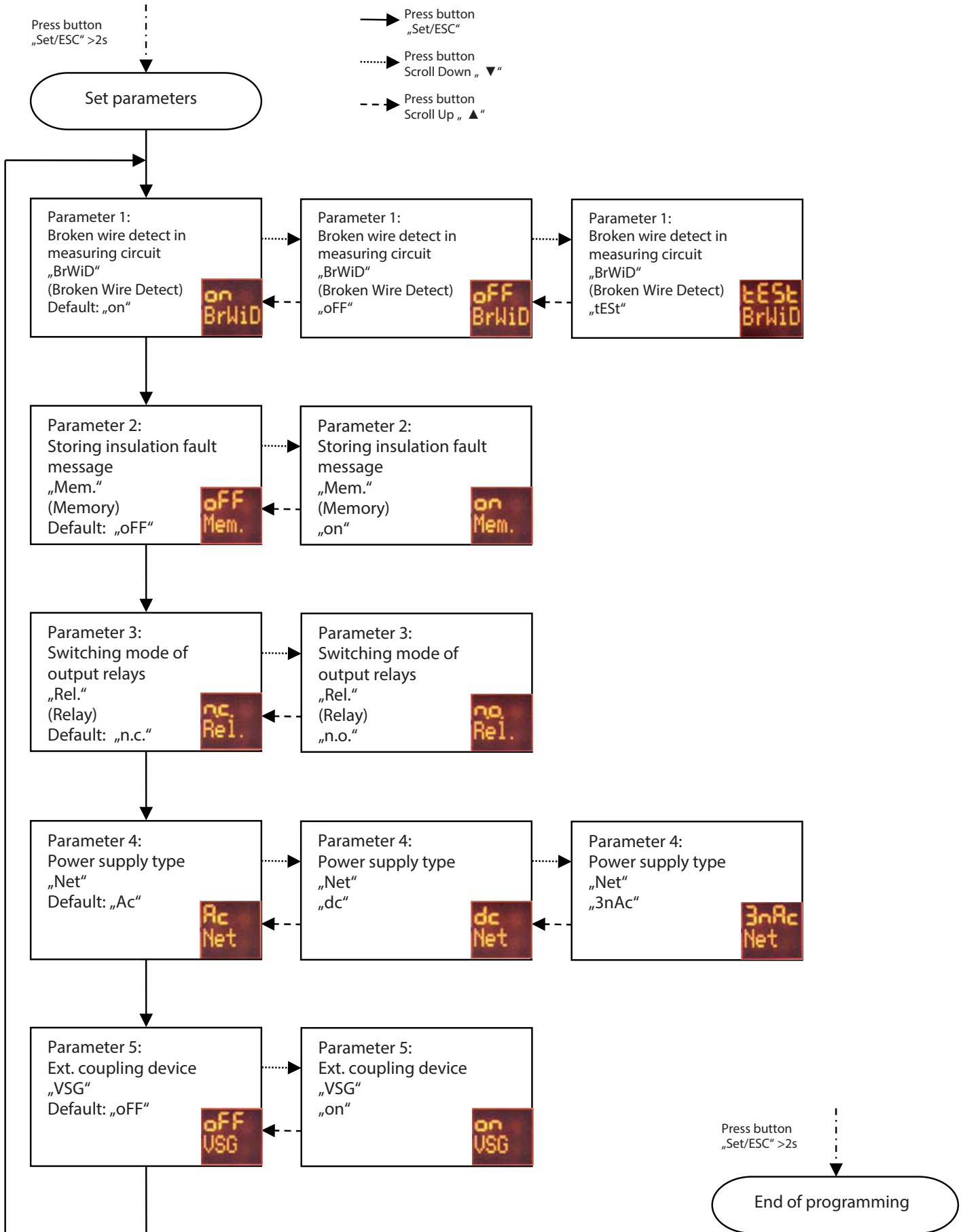

## Technical Data

### Measuring circuit L(+)/L(-) to PE1/PE2 (without coupling device)

<b>Nominal voltage <math>U_N</math>:</b>	AC / DC 0 ... 230 V
<b>Max. voltage range <math>U_N</math>:</b>	AC 0 ... 250 V DC 0 ... 300 V
<b>Frequency range:</b>	DC or 40 ... 1000 Hz
<b>Max. line capacitance:</b>	5 $\mu$ F
<b>Internal resistance (AC / DC):</b>	> 90 k $\Omega$
<b>Measuring voltage:</b>	approx. $\pm$ 90 V
<b>Max. measured current (<math>R_E = 0</math>):</b>	< 1.10 mA
<b>Response inaccuracy:</b>	$\pm$ 15 % $\pm$ 1.5 k $\Omega$ IEC 61557-8
<b>Response value hysteresis:</b>	Approx. + 25 %; min. + 1 k $\Omega$

#### On delay

at  $C_E = 1 \mu$ F,  
response value  $\leq$  100 k $\Omega$ ,  
 $R_E$  of  $\infty$  to 0.5 \* response value:  $\leq$  1 s

at  $C_E = 1 \mu$ F,  
response value > 100 k $\Omega$ ,  
 $R_E$  of  $\infty$  to 0.5 \* response value: < 2 s

#### Measuring time:

at  $C_E = 1 \dots 5 \mu$ F < 5 s

**Min. operate time:** > 0.2 s

#### Response values

Pre-warning ( $R_{PA}$ ):

k $\Omega$ :	20	30	50	70	100	200	300	500
--------------	----	----	----	----	-----	-----	-----	-----

Alarm ( $R_A$ ):

k $\Omega$ :	1	2	10	20	30	50	70	100
--------------	---	---	----	----	----	----	----	-----

each adjustable via rotational switches

#### Response value broken

**wire detection L(+)/L(-):** > Approx. 90 k $\Omega$

#### Response value broken-

**wire detection PE1/PE2:** > Approx. 0.5 k $\Omega$

### Meas. circuit L1(+)/L2(-) to PE1/PE2 (with coupling device RL / RP 5898)

	<b>RL 5898</b>	<b>RP 5898</b>
<b>Nominal voltage <math>U_N</math>:</b>	AC 0 ... 400 V DC 0 ... 500 V	AC 0 ... 690 V DC 0 ... 1000 V
<b>Max. max. voltage range <math>U_N</math>:</b>	AC 0 ... 440 V DC 0 ... 550 V	AC 0 ... 760 V DC 0 ... 1100 V
<b>Frequency range:</b>	DC or 40 ... 1000 Hz	
<b>Max. line capacitance:</b>	5 $\mu$ F	
<b>Innenwiderstand (AC / DC):</b>	> 240 k $\Omega$	
<b>Messspannung:</b>	Approx. $\pm$ 90 V	
<b>Max. measured current (<math>R_E = 0</math>):</b>	< 0.40 mA	
<b>Response inaccuracy:</b>	$\pm$ 15 % $\pm$ 1.5 k $\Omega$ IEC 61557-8	
<b>Response value hysteresis:</b>	Approx. + 25 %; min. + 1 k $\Omega$	

#### On delay

at  $C_E = 1 \mu$ F,  
response value  $\leq$  100 k $\Omega$ ,  
 $R_E$  of  $\infty$  to 0.5 \* response value:  $\leq$  1 s

at  $C_E = 1 \mu$ F,  
response value > 100 k $\Omega$ ,  
 $R_E$  of  $\infty$  to 0.5 \* response value: < 2 s

#### Measuring time:

at  $C_E = 1 \dots 5 \mu$ F < 5 s

**Min. operate time:** > 0.2 s

#### Response values

Pre-warning ( $R_{PA}$ ):

k $\Omega$ :	20	30	50	70	100	200	300	500
--------------	----	----	----	----	-----	-----	-----	-----

Alarm ( $R_A$ ):

k $\Omega$ :	1	2	10	20	30	50	70	100
--------------	---	---	----	----	----	----	----	-----

each adjustable via rotational switches

#### Response value broken

**wire detection L1(+)/L2(-):** > Approx. 500 k $\Omega$

#### Response value broken

**wire detection PE1/PE2:** > Approx. 0.5 k $\Omega$

#### Max. wire length

**between insulation monitor and coupling device:** < 0.5 m

### Auxiliary voltage input A1(+)/A2

Nom. Voltage	Voltage range	Frequency range
AC/DC 24 ... 60 V	AC 19 ... 68 V	45 ... 400 Hz; DC 48 % W*)
	DC 16 ... 96 V	W*) $\leq$ 5 %
AC/DC 85 ... 230 V	AC 68 ... 276 V	45 ... 400 Hz; DC 48 % W*)
	DC 67 ... 300 V	W*) $\leq$ 5 %
DC 12 ... 24 V	DC 9.6 ... 30 V	W*) $\leq$ 5 %

\*) W = permitted residual ripple of auxiliary supply

## Technical Data

### Nominal consumption:

DC 12 V, 24 V, 48 V:	max. 3 W
AC 230 V:	max. 3.5 VA

### Control input X1/X2 for external kombinierte Test-/Reset-Taste

<b>Current flow:</b>	approx. 3 mA
<b>No-load operation voltage X1 to X2:</b>	approx. 12 V
<b>Permissible wire length:</b>	< 50 m
<b>Activat. time t for test signal:</b>	1.5 s < t < 10 s
<b>Activat. time t for reset signal:</b>	t < 1.5 s
<b>Activation time t for Stop of the measuring function:</b>	t > 10 s

### Outputs

<b>Indicator contact:</b>	2 x 1 changeover contact for Alarm (K1) and Pre-Alarm (K2) energized or de-energized on trip (programmable)
<b>Thermal current <math>I_{th}</math>:</b>	4 A

#### Switching capacity

to AC 15:

NO contact: 5 A / AC 230 V IEC/EN 60947-5-1

NC contact: 2 A / AC 230 V IEC/EN 60947-5-1

to DC 13: 2 A / DC 24 V IEC/EN 60947-5-1

#### Electrical life

at 5 A, AC 230 V: 1 x 10<sup>5</sup> switching cycles

#### Short circuit strength

**max. fuse rating:** 4 A gG / gL IEC/EN 60947-5-1

#### Mechanical life:

50 x 10<sup>6</sup> switching cycles

### General Data

#### Operating mode:

Continuous operation

#### Temperature range

Operation: - 30 ... + 60 °C  
(at range 0 ... -30 °C limited function of the LCD display)

#### Storage:

**Altitude:** - 30 ... + 70 °C IEC 60664-1

#### Clearance and creepage distances

Rated insulation voltage: 300 V

Overvoltage category: III

rated impuls voltage / pollution degree: IEC 60664-1

measuring circuit L(+)/L(-) to

auxiliary voltage A1(+)/A2 and indicator relay contacts K1, K2 and trigger output Y1/Y2: 4 kV / 2

auxiliary voltage A1(+)/A2 to indicator relay contacts K1, K2 und trigger output Y1/Y2: 4 kV / 2

indicator relay contact K1 to indicator relay contacts K2: 4 kV / 2

trigger output Y1/Y2 to indicator relay contacts K1, K2: 4 kV / 2

Insulation test voltage

Routine test: AC 2.5 kV; 1 s

#### EMC

Electrostatic discharge (ESD): 8 kV (air) IEC/EN 61000-4-2

HF irradiation:

80 MHz ... 1 GHz: 20 V / m IEC/EN 61000-4-3

1 GHz ... 2.7 GHz: 10 V / m IEC/EN 61000-4-3

Fast transients: 2 kV IEC/EN 61000-4-4

#### Surge voltage

between wires for power supply: 1 kV IEC/EN 61000-4-5

between wire and ground: 2 kV IEC/EN 61000-4-5

HF-wire guided: 20 V IEC/EN 61000-4-6

Interference suppression: Limit value classe B EN 55011

#### Degree of protection

Housing: IP 40 IEC/EN 60529

Terminals: IP 20 IEC/EN 60529

#### Housing:

Thermoplastic with V0 behaviour according to UL subject 94

#### Vibration resistance:

Amplitude 0.35 mm, Frequency 10 ... 55 Hz, IEC/EN 60068-2-6

frequency 2 ... 13.2 Hz, 13.2 ... 100 Hz, acceleration  $\pm$  0.7 gn IEC/EN 60068-2-6

10 gn / 11 ms, 3 pulses IEC/EN 60068-2-27

**Shock resistance:** 30 / 060 / 04 IEC/EN 60068-1

**Climate resistance:** EN 50005

**Terminal designation:**



## Technical Data

<b>Wire connection</b>	DIN 46228-1/-2/-3/-4	
Cross section:	0.5 ... 4 mm <sup>2</sup> (AWG 20 - 10) solid or 0.5 ... 4 mm <sup>2</sup> (AWG 20 - 10) stranded wire without ferrules 0.5 ... 2.5 mm <sup>2</sup> (AWG 20 - 10) stranded wire with ferrules	
Stripping length:	6.5 mm	
<b>Wire fixing:</b>	Cross-head screw / M3 box terminals	
<b>Fixing torque:</b>	0.5 Nm	
<b>Mounting:</b>	DIN rail	IEC/EN 60715
<b>Weight:</b>	approx. 205 g	

## Dimensions

Width x height x depth: 52.2 x 90 x 71 mm

## Classification to DIN EN 50155

<b>Vibration and shock resistance:</b>	Category 1, Class B	IEC/EN 61373
<b>Ambient temperature:</b>	T1, T2 compliant	
<b>Protective coating of the PCB:</b>	No	

## UL-Data

Meas. circuit L1(+)/L2(-) to PE1/PE2 (with coupling device RL / RP 5898)

	RL 5898	RP 5898
<b>Max. voltage range U<sub>N</sub>:</b>	AC 0 ... 400 V DC 0 ... 500 V	AC 0 ... 600 V DC 0 ... 600 V

**Output voltage at L(+)/L(-), VSG1/VSG2:** max. AC / DC 230 V

**Switching capacity:** Pilot duty C300, R300  
5A 250Vac  
2A 30Vdc

**Wire connection:** 60 °C / 75 °C copper conductors only  
Torque 0.5 Nm



Technical data that is not stated in the UL-Data, can be found in the technical data section.

## Standard Types

RN 5897.12/020	DC 12 ... 24 V
Article number:	0068260
• Auxiliary voltage:	DC 12 ... 24 V
RN 5897.12/020	AC/DC 24 ... 60 V
Article number:	0068258
• Auxiliary voltage:	AC/DC 24 ... 60 V
RN 5897.12/020	AC/DC 85 ... 230 V
Article number:	0068259
• Auxiliary voltage:	AC/DC 85 ... 230 V
• Outputs:	1 changeover contact for pre-warning 1 changeover contact for alarm
• Setting range pre-warning:	20 kΩ ... 500 kΩ
• Setting range alarm:	1 kΩ ... 100 kΩ
• With connection facility of a coupling device RL 5898 or RP 5898	
• Max. line capacitance:	5 μF
• Energized or de-energized on trip	
• Selection of type of network	
• Width:	52.5 mm

## Ordering Example for variants

RN 5897	.12	/020	/61	AC/DC 24 ... 60 V	1 kΩ - 100 kΩ	20 kΩ - 500 MΩ
---------	-----	------	-----	-------------------	---------------	----------------

Setting range Pre-warning  
Setting range alarm  
Auxiliary voltage  
UL approval  
Variant, if required  
Contacts  
Type

## Accessories

- RL 5898:  
Article number: 0068315
- Coupling device for RN 5897.12/020
  - Extension of nominal voltage range U<sub>N</sub> to DC 500 V, AC 400 V
  - Weight: approx. 60 g
  - Dimensions
    - Width x height x depth: 35 x 90 x 71 mm

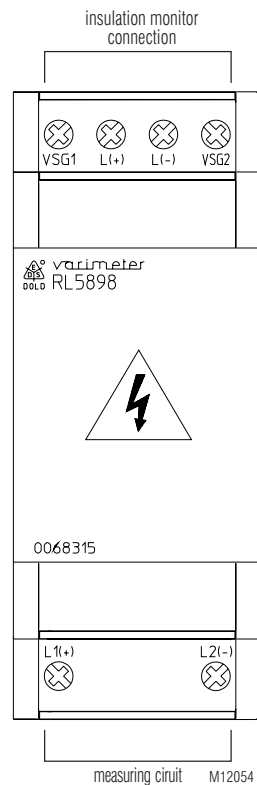

## Accessories

RP5898:

Article number: 0066944

- Coupling device for RN 5897.12/020
- Extension of nominal voltage range  $U_N$  to DC 1000 V, AC 690 V
- Weight: approx. 110 g
- Dimensions
  - Width x height x depth: 70 x 90 x 71 mm

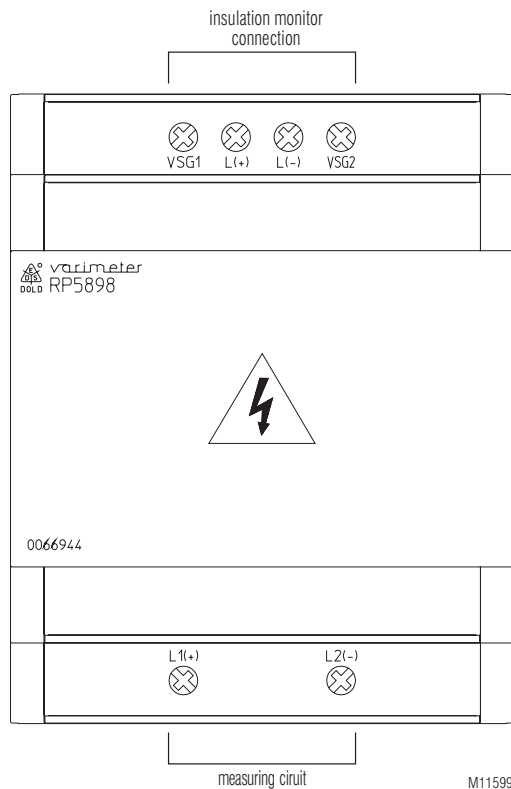

M11599

## Accessories

### Flush mounting kit

Order reference: KU 4087-150/0056598

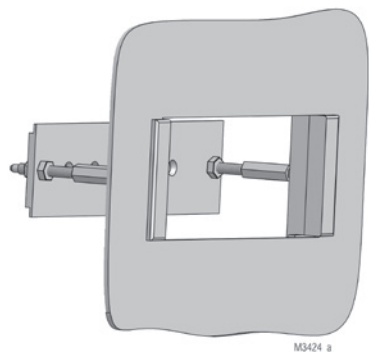

For universal use with:

- R-series devices of 17.5 to 105 mm width
- easy mounting

M3424 a

## Connection Example

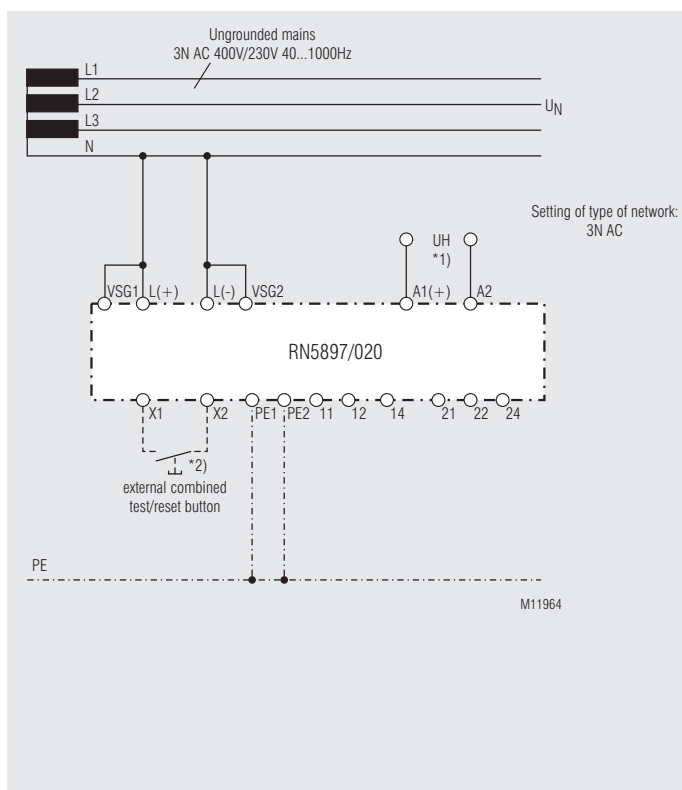

M11964

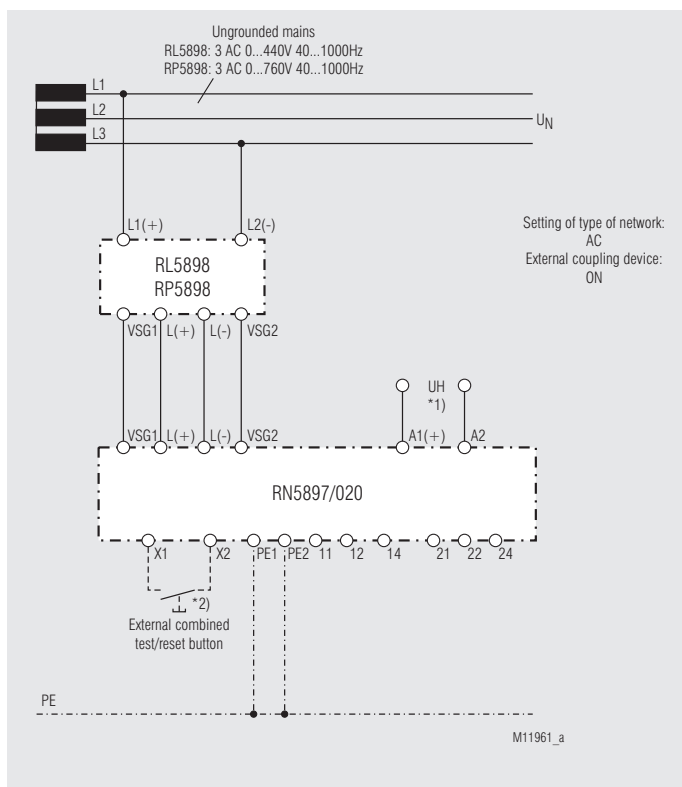

M11961\_a

\*1) Auxiliary voltage  $U_H$  (A1(+)/A2) ) can also be sourced from the monitored voltage system.  
The voltage range of the auxiliary supply has to be taken into account.

\*2) Control input X1/X2 for external combined Test-/Reset-button with Stop of the measuring function:

- Control 1.5 s < t < 10 s: Test function
- Control < 1.5 s: Reset function
- Control > 10 s: Stop of measuring function

## Connection Example

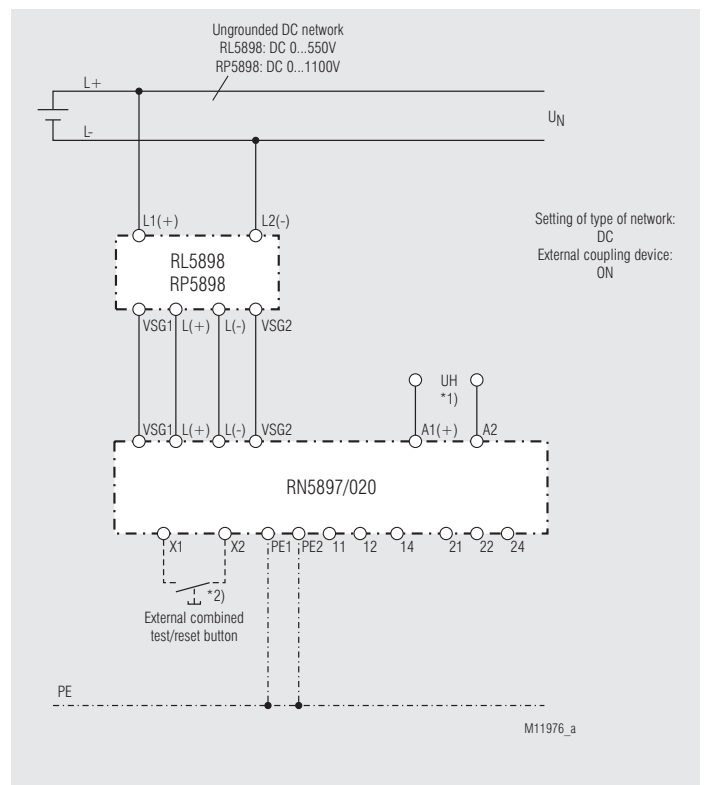
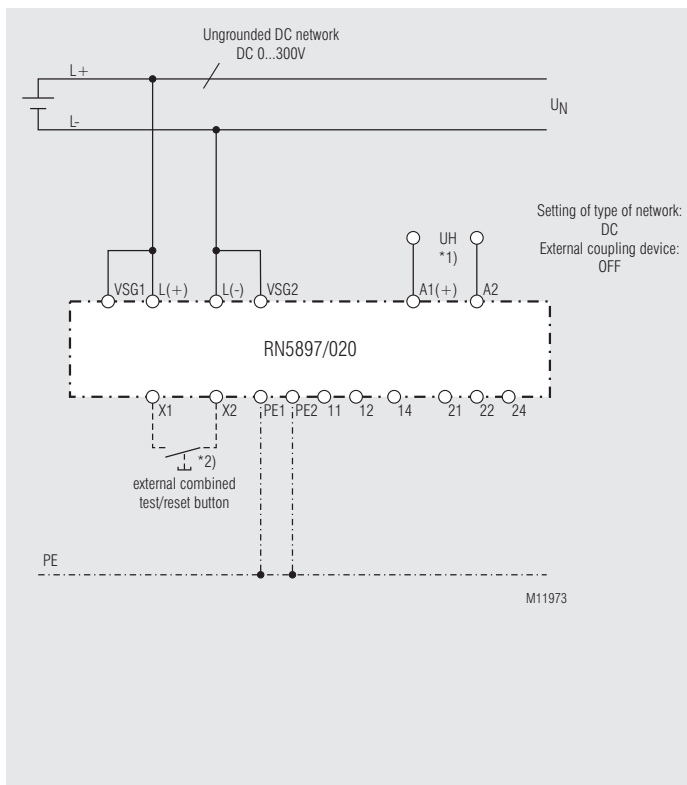
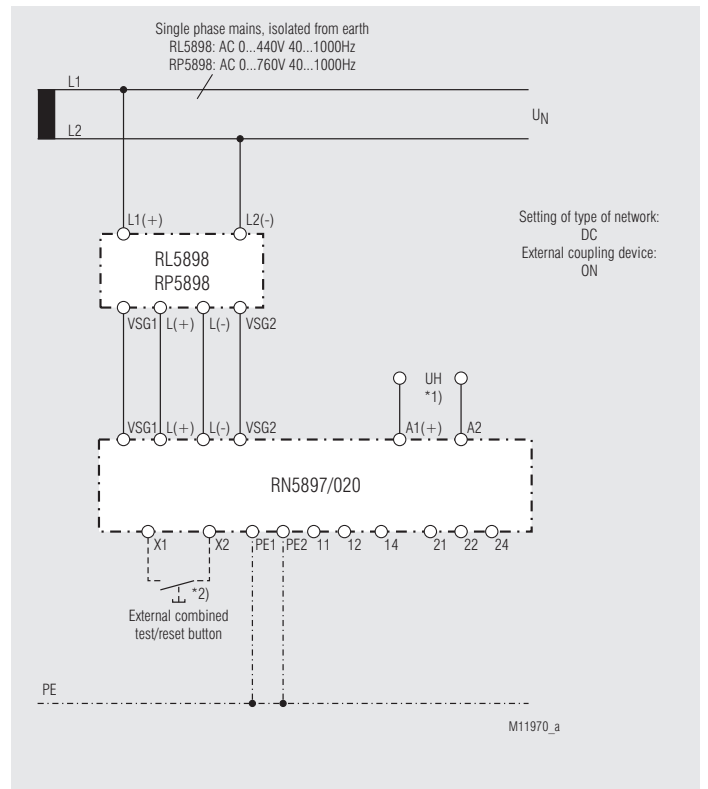
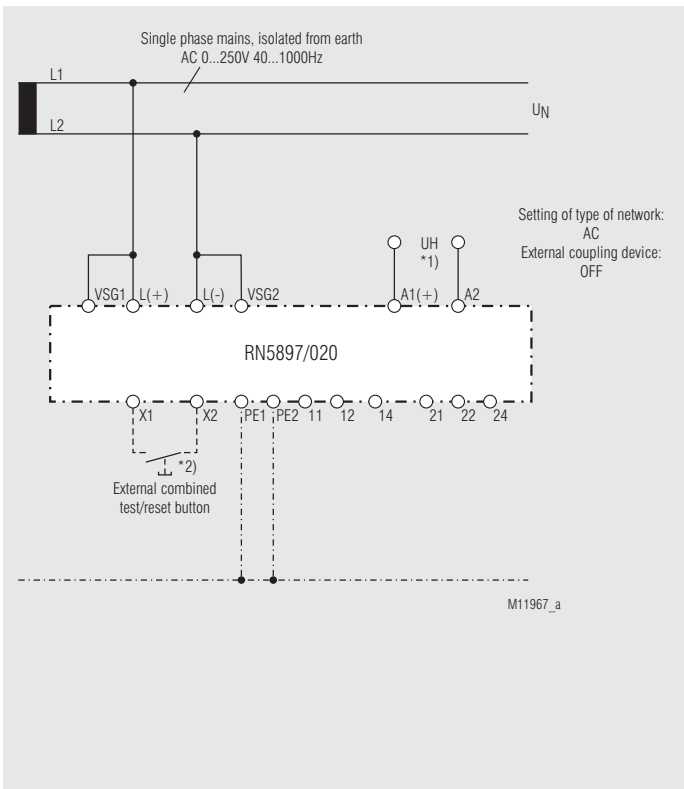

\*1) Auxiliary voltage  $U_H$  (A1(+)/A2) can also be sourced from the monitored voltage system.  
The voltage range of the auxiliary supply has to be taken into account.

\*2) Control input X1/X2 for external combined Test-/Reset-button with Stop of the measuring function:

- Control  $1.5 \text{ s} < t < 10 \text{ s}$ : Test function
- Control  $< 1.5 \text{ s}$ : Reset function
- Control  $> 10 \text{ s}$ : Stop der Messfunktion

