

OEPQ 12 M 5000 G2-TSSL High Performance Photoelectric Sensor, Receiver

- Operating distances up to 5 m
- Integrated amplifier electronics
- Transistor output with push-pull
- High functional reserve
- Extremely dirt-resistant
- Easy adjustment
- Different designs to be combined
- High protection class
- Compact design

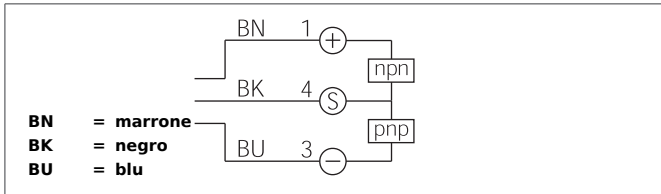
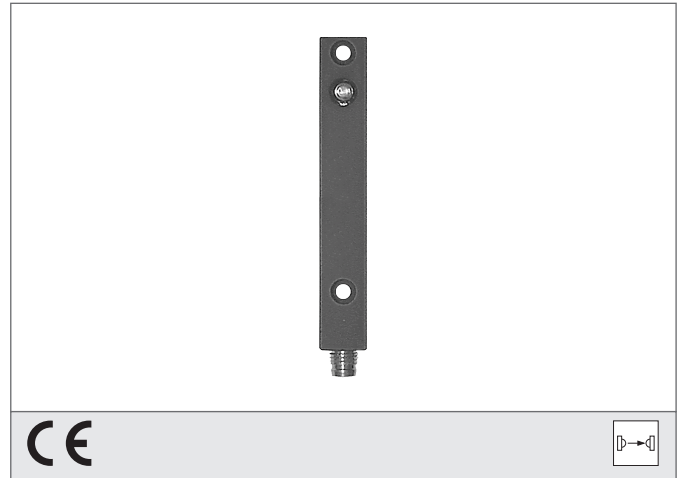

Safety instructions

The Instruments are not to be used for safety applications, in particular applications in which safety of persons depends on proper operation of the instruments.

These instruments shall exclusively be used by qualified personnel.

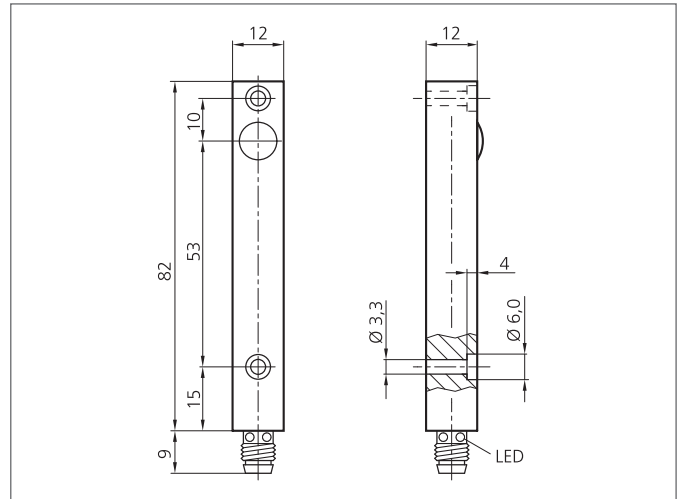

TECHNICAL INFORMATION (typ.)		+20°C, 24V DC
Operating principle		Through beam sensors, receiver, switching output
Evaluation		digital
Size		82 x 12 x 12 mm (Dimensions)
Design		cuboid design
Characteristics		High transmit power and dirt penetration
Service voltage		10 ... 35 V DC
No-load current		< 40 mA
Operating distance		0 ... 5000 mm dependent on the transmitter
Sensitivity adjustment		no setting elements
Switching output		Push pull, 200 mA, NO
Shock-/vibration load		10 ... 55 Hz / 1,0 mm / 30 g
Switching frequency		500 Hz
Ambient temperature, operation		-20 ... +60 °C
Ambient light immunity		15 kLx, Sunlight, 2 kLx, clocked light
Protection class		IP 67
Protection degree		III, operation on protective low voltage
Casing material		Aluminium anodized
Connection		Connector, M8, 3-poled