

OGL 50/31 P6L-IBS/PE

High Performance Angled Light Barrier

- Intelligent contamination output with LED
- High functional reserve
- Extremely dirt-resistant
- Advanced PE-contact
- Optical axis approachable in x-, y- and z-direction
- All-purpose mounting
- Robust metal casing

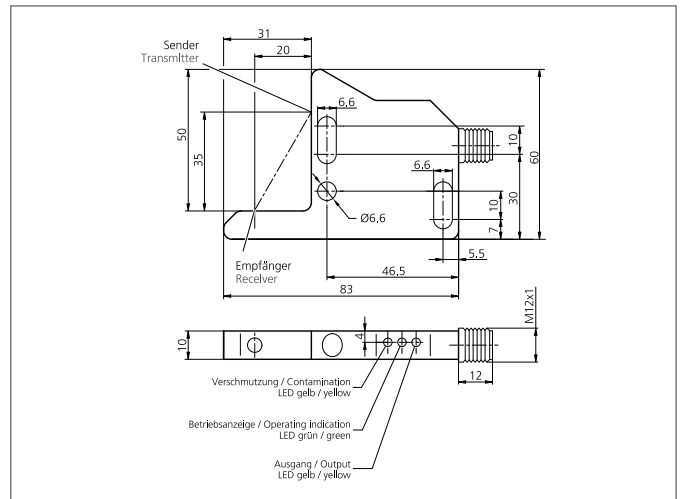
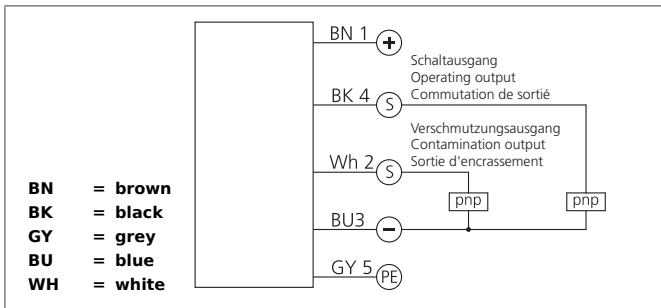
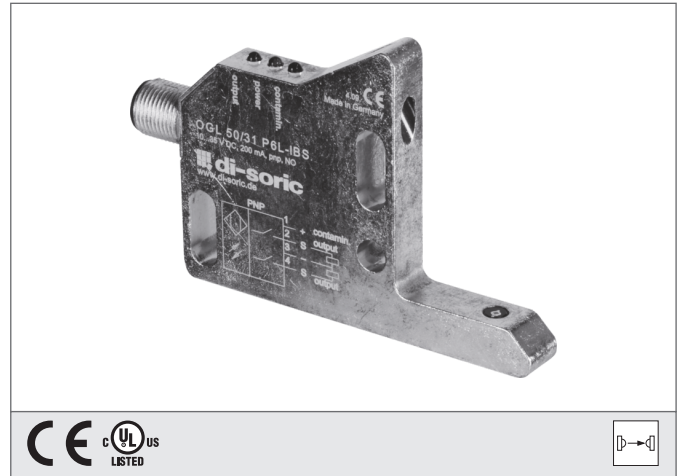

Safety instructions

The Instruments are not to be used for safety applications, in particular applications in which safety of persons depends on proper operation of the instruments.

These instruments shall exclusively be used by qualified personnel.

TECHNICAL INFORMATION (typ.)	+20°C, 24V DC
Operating principle	Optical
Evaluation	digital
Size	60 x 83 x 10 mm (Dimensions)
Design	Angle
Branch length inside	50/31 mm
Characteristics	High transmit power and dirt penetration
Emitted light	Red, 660 nm, clocked
Service voltage	10 ... 35 V DC (Supply Class 2)
No-load current	< 45 mA
Operating distance	40 mm (optical axis)
Sensitivity adjustment	no setting elements
Switching output	pnp, 200 mA, NO
Contamination output	pnp, 200 mA
Shock-/vibration load	10 ... 55 Hz / 1,0 mm / 30 g
Voltage drop	< 2,0 V
Switching frequency	200 Hz
Ambient temperature, operation	-10 ... +60 °C
Ambient light immunity	5 kLx
Insulation voltage endurance	500 V
Protection class	IP 67
Protection degree	III, operation on protective low voltage
Casing material	Die-cast zinc
Connection	Connector, M12, 5-poled

OGL 50/31 P6L-IBS/PE
High Performance Angled Light Barrier



TECHNICAL INFORMATION (typ.)

+20°C, 24V DC

Connecting cable

VK ...