

- Coupling M12, 4-poled / Connector M8, 4-poled
- 可旋金属螺丝
- 高防护等级, IP67

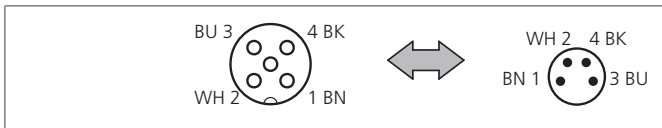

Safety instructions

The Instruments are not to be used for safety applications, in particular applications in which safety of persons depends on proper operation of the instruments. These instruments shall exclusively be used by qualified personnel.

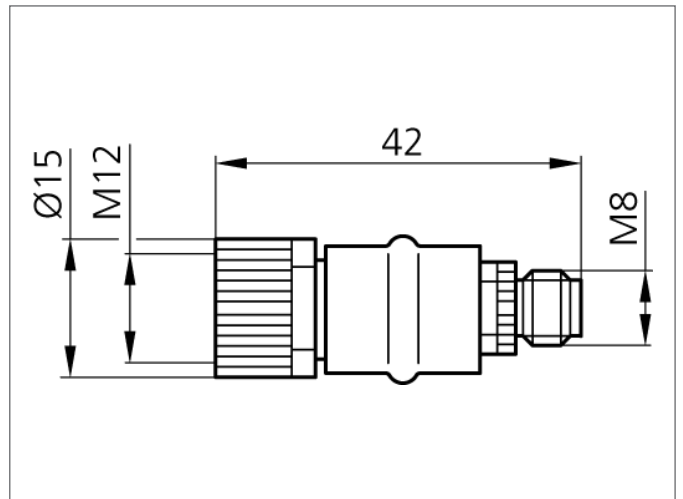

TECHNICAL INFORMATION (typ.)

设计	直的
工作电压	< 24 V 最大4.0 A
防护等级	IP 67
外壳材料	plastics
Connection sensor side	Socket, M12x1, 4-poled
Connection control side	Connector, M8x1, 4-poled