

SH-8-10 Sensor Holder Ø 8mm

- Highly flexible versatile mounting system
- All-purpose mounting
- Smooth adjustment
- Robust design

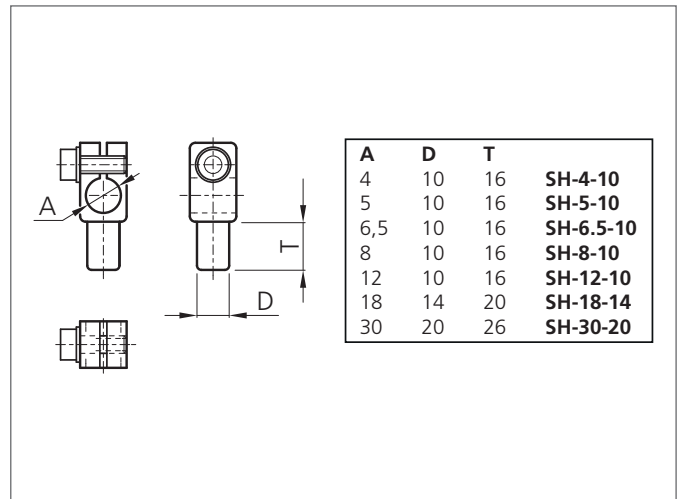
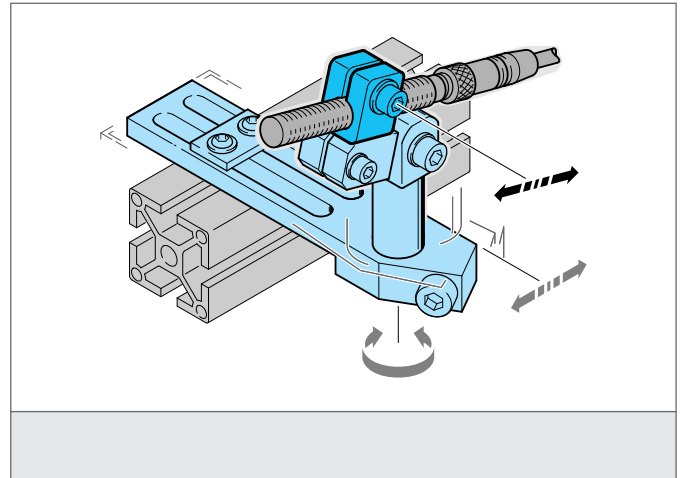

TECHNICAL INFORMATION (typ.)

Size

+20°C, 24V DC

8,0 mm (Diameter A)
10 mm (Spacer measure D)

Suitable for

Clamping pin 10 mm

Casing material

polyamide

Product series

System holder HS