

KFS 3/8 T 100 PSOLK-KL

Capacitive Level Probe

- Level control for conductive, non-conductive and viscous materials
- Probe rod made of teflon
- High temperature range
- High protection class

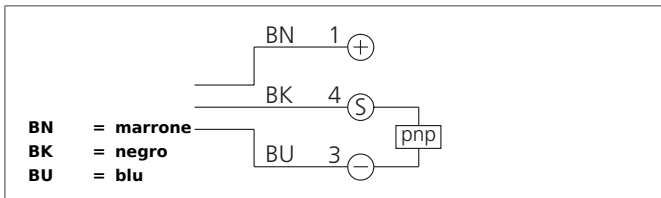

Safety instructions

The Instruments are not to be used for safety applications, in particular applications in which safety of persons depends on proper operation of the instruments.

These instruments shall exclusively be used by qualified personnel.

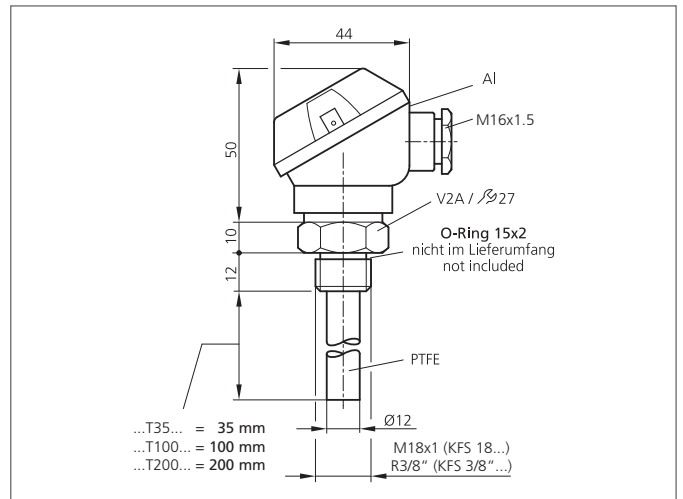

TECHNICAL INFORMATION (typ.)	+20°C, 24V DC
Size	R 3/8 Zoll (thread)
Teflon probe lengths	100 mm
Maximum rating	100 mA
Service voltage	10 ... 35 V DC
No-load current	< 10 mA
Switching output	pnp, 100 mA, NO/NC
Switching hysteresis	material dependent
Voltage drop	< 2,0 V
Switching frequency	< 5 Hz
Ambient temperature, operation	-30 ... +100 °C
Temperature resistance	+ 125 °C (medium temperature)
Insulation voltage endurance	500 V
Protection class	IP 67, (connection compartment), IP 68, (probe)
Casing material	stainless steel V4A, (1.4404 / AISI 316L), medium-touching
Material	PTFE Teflon (Probe rod)
Connection	clamps
Pressure resistant	10 bar