

OGUTI 031 P3K-TSSL

Fork Light Barrier

- Fast, simple, reliable: sensitivity adjustment via the teach key
- Auto-teach during a running process
- LED indicator for the teach procedure
- Detection of even the smallest objects
- Large functional reserve
- Light/dark switching
- 5-year warranty

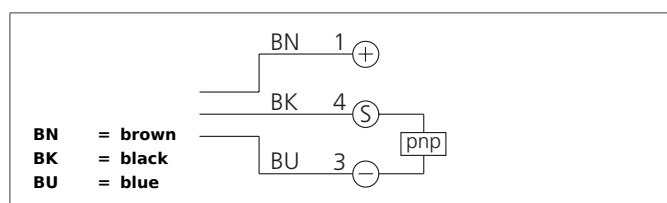

Safety instructions

The Instruments are not to be used for safety applications, in particular applications in which safety of persons depends on proper operation of the instruments.

These instruments shall exclusively be used by qualified personnel.

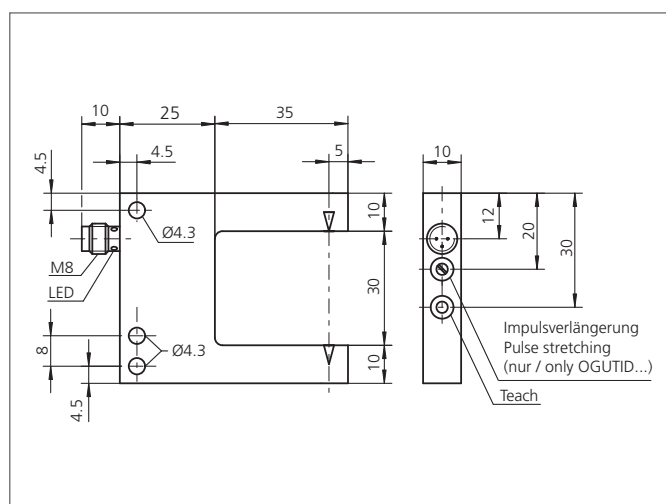

TECHNICAL INFORMATION (typ.)	+20°C, 24V DC
Operating principle	Optical
Evaluation	digital
Size	50 x 60 x 10 mm (Dimensions)
Design	fork
Fork opening	30 mm
Branch length inside	35 mm
Emitted light	Red, clocked
Service voltage	10 ... 35 V DC (Supply Class 2)
No-load current	< 30 mA
Resolution	Ø 0,3 mm
Sensitivity adjustment	Teach key
Switching output	pnp, 200 mA, NO/NC, switchable
Switching hysteresis	< 0,1 mm
Shock-/vibration load	10 ... 55 Hz / 1,0 mm / 30 g
Voltage drop	< 2,0 V
Switching frequency	< 3,0 kHz
Reproducibility	< 0,03 mm
Ambient temperature, operation	-10 ... +60 °C
Ambient light immunity	20 kLx
Insulation voltage endurance	500 V
Protection class	IP 67
Protection degree	III, operation on protective low voltage
Casing material	Die-cast zinc black lacquered finish

OGUTI 031 P3K-TSSL

Fork Light Barrier



TECHNICAL INFORMATION (typ.)		+20°C, 24V DC
Connection		Connector, M8, 3-poled
Connecting cable		TK ...