

- 高度灵活的安装系统
- 多用途安装
- 调节简单
- 结实耐用的设计

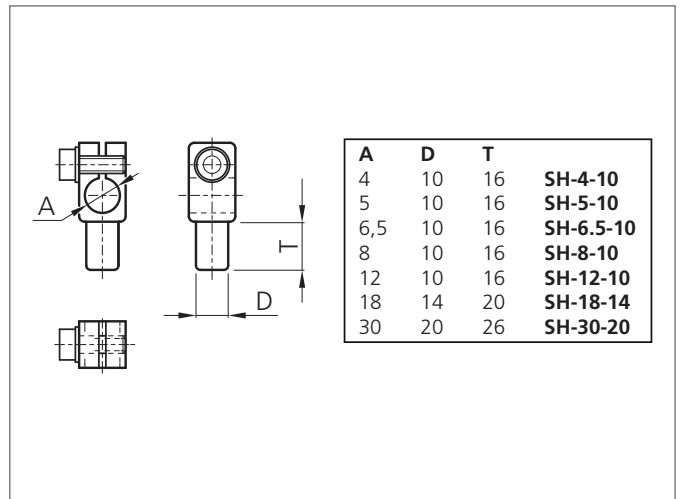
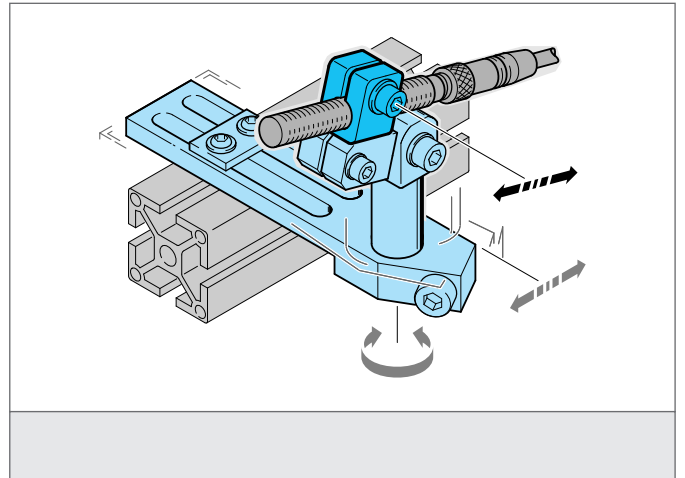

TECHNICAL INFORMATION (typ.)	
尺寸	+20°C, 24V DC 5,0 mm (直径A) 10 mm (间隔测量C)
为了	Clamping pin 10 mm
外壳材料	polyamide
产品系列	系统支架HS