

SH 18 A Sensor Holder

- For cylindrical Sensors of \varnothing 18 mm or thread M18
- Simple installation
- Reduced mounting/downtimes thanks to one-piece construction
- Sensor exchange without changing the clamp position
- Limit stop for sensor exchange without readjustment
- Oblong holes permit clamp adjustment

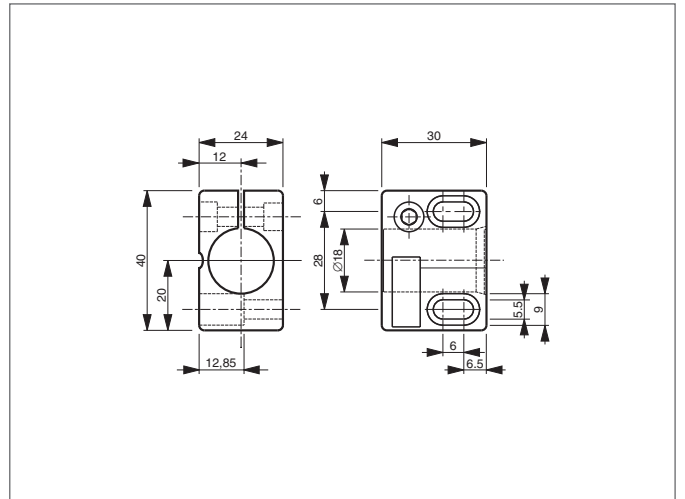

TECHNICAL INFORMATION (typ.)	+20°C, 24V DC
Hole spacing	28 mm
Size	24 x 30 x 40 mm (Dimensions) 18 mm (Clamping diameter G)
Characteristics	with limit stop
Casing material	plastics (polyamide - PA 6 GK)

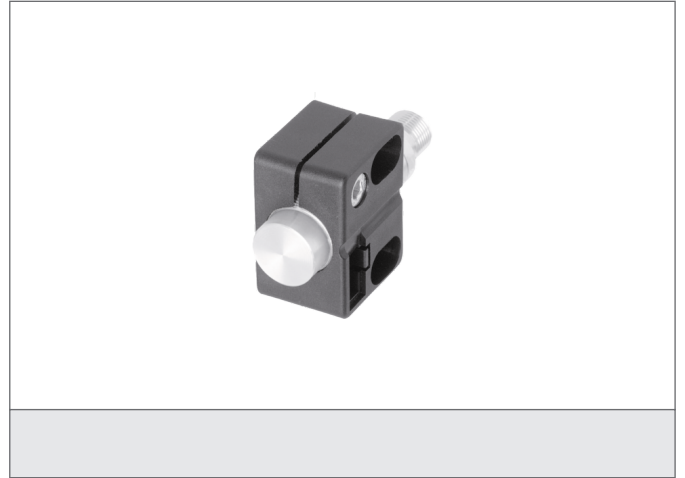