

MZ-S-8/6.5 Sensor clamp

- Reliable mounting of cylinder sensors at round cylinders
- High locking power
- Robust casing
- For a quick and easy fix and mounting of sensors

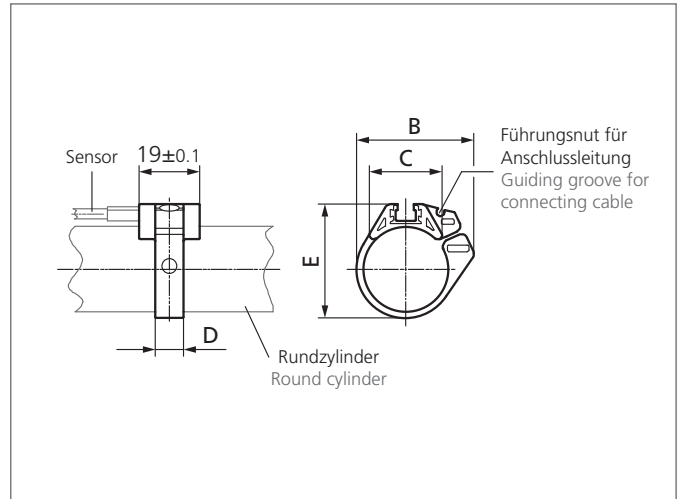
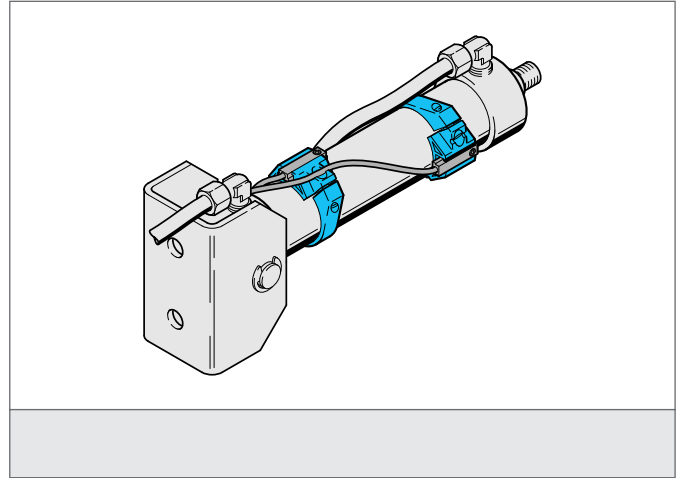

TECHNICAL INFORMATION (typ.)

Size	18.9 mm (Spacer measure B) 12.3 mm (Spacer measure C) 7 mm (Spacer measure D) 17.5 mm (Spacer measure E)
Mounting	at round cylinders
Suitable for	Cylinder sensores with T-Slot
Casing material	Aluminium / ring POM, (polyacetal - POM)
Application	Cylinder Ø 8 mm
Scope of delivery	Fixing material