

MZ-S-8/6.5

Collier de détecteur

- Reliable mounting of cylinder sensors at round cylinders
- High locking power
- Robuste boîtier
- Pour une rapide fixation et installation des capteurs

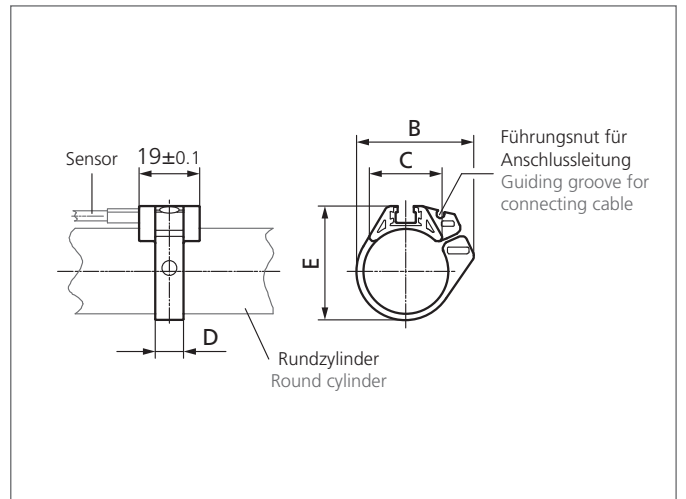
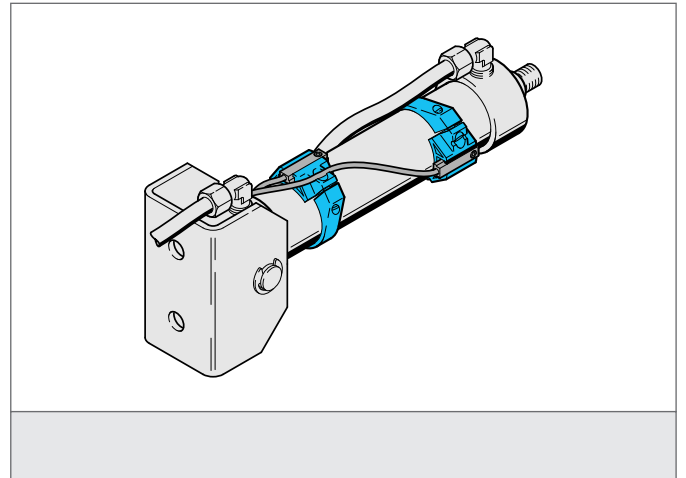

CARACTÉRISTIQUES TECHNIQUES (typ.)

Dimensions	18.9 mm (Spacer measure B) 12.3 mm (Spacer measure C) 7 mm (Spacer measure D) 17.5 mm (Spacer measure E)
Montage	at round cylinders
Approprié pour	Cylinder sensores with T-Slot
Matériau du boîtier	Aluminium / anneau POM, (polyacetal - POM)
Application	Cylindre Ø 8 mm
Contenu de la livraison	Matériel de fixation