

MZ-S-50/6.5 Sensor clamp

- Reliable mounting of cylinder sensors at round cylinders
- High locking power
- Robust casing
- For a quick and easy fix and mounting of sensors

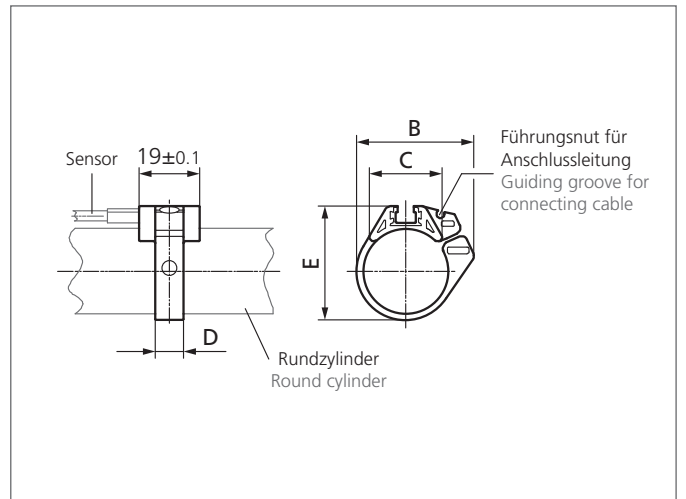
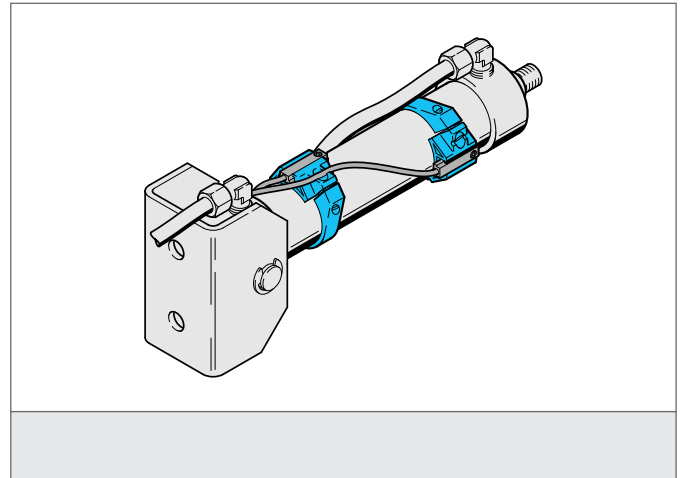

TECHNICAL INFORMATION (typ.)

Size	56.4 mm (Spacer measure B) 28.6 mm (Spacer measure C) 9 mm (Spacer measure D) 61.5 mm (Spacer measure E)
Mounting	at round cylinders
Suitable for	Cylinder sensors with T-Slot
Casing material	Aluminium / ring POM, (polyacetal - POM)
Application	Cylinder Ø 50 mm
Scope of delivery	Fixing material