

- 磁敏开关在圆形气缸上可靠的安装
- 高锁功率
- 耐用的外壳
- 用于快速简单安装传感器

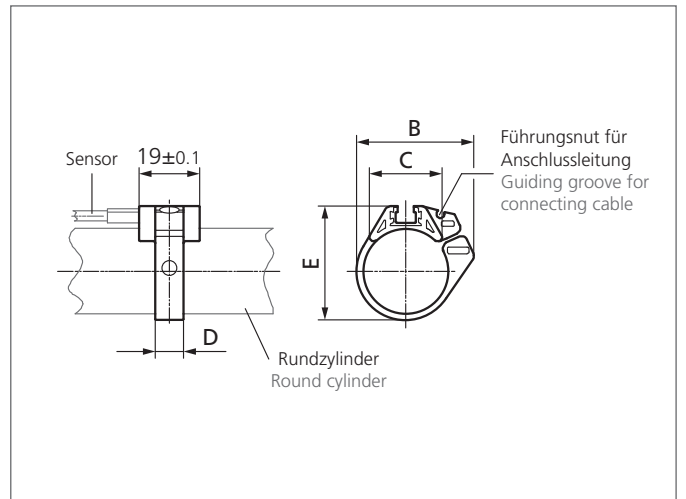
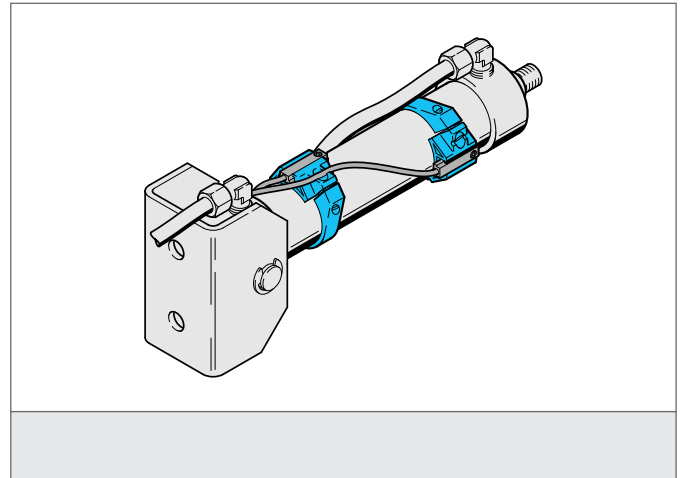

TECHNICAL INFORMATION (typ.)

尺寸	41.7 mm (间隔测量B) 24.6 mm (间隔测量C) 9 mm (间隔测量C) 42.7 mm (间隔测量E)
安装	用在圆形气缸上
为了	Cylinder sensores with T-Slot
外壳材料	Aluminium / ring POM, (polyacetal - POM)
用于	Cylinder 32 mm
交货范围	Fixing material