

- 可调节
- 结实耐用的设计

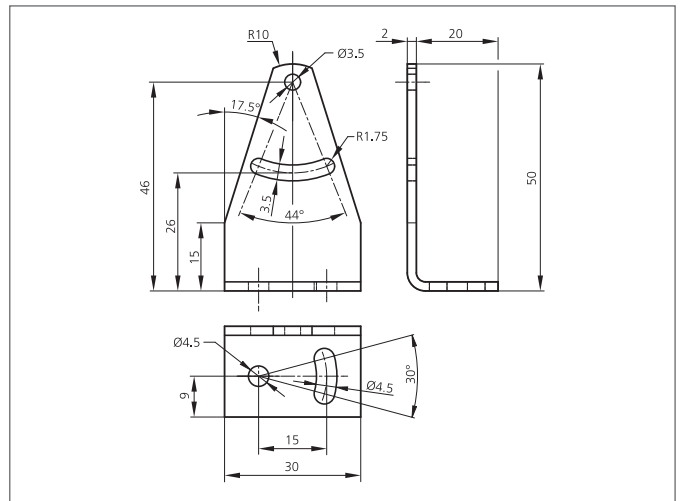

TECHNICAL INFORMATION (typ.)

孔间距	20 mm
安装孔	3.5 mm
外壳材料	metal