

BW 41 Mounting Bracket

- Adjustable
- Robust design

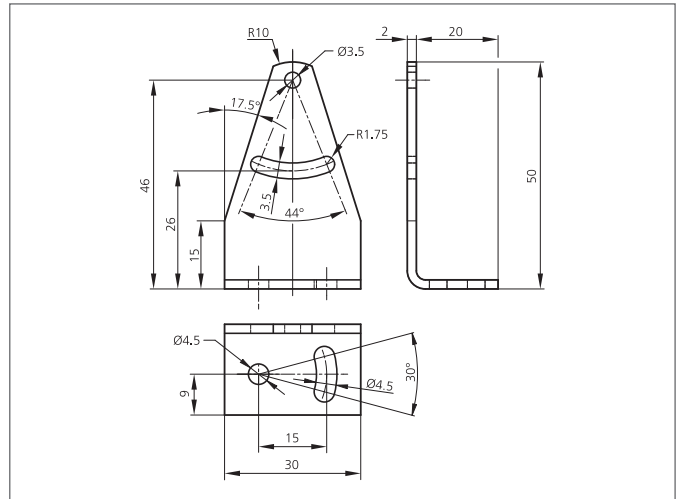

TECHNICAL INFORMATION (typ.)

Hole spacing	20 mm
Mounting hole	Ø 3,5 mm
Casing material	metal