

SH-30-20

Sensor Holder Ø 30mm

- Highly flexible versatile mounting system
- All-purpose mounting
- Smooth adjustment
- Robust design

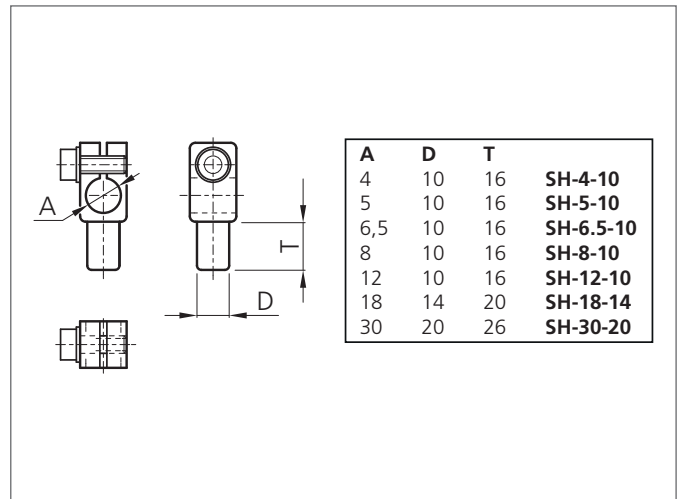
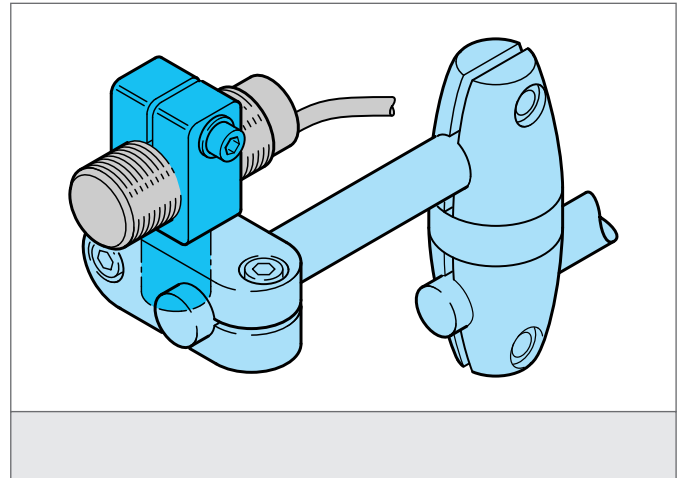

TECHNICAL INFORMATION (typ.)	
Size	+20°C, 24V DC 30 mm (Diameter A) 20 mm (Spacer measure D)
Suitable for	Clamping pin 20 mm
Casing material	polyamide
Product series	System holder HS