

SH-WSL-L-14-40-U

Angle clamp

- Highly flexible versatile mounting system
- All-purpose mounting
- Smooth adjustment
- Robust design

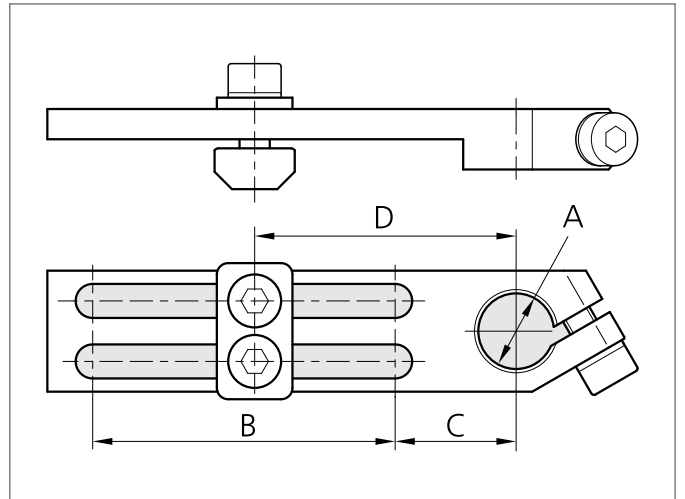
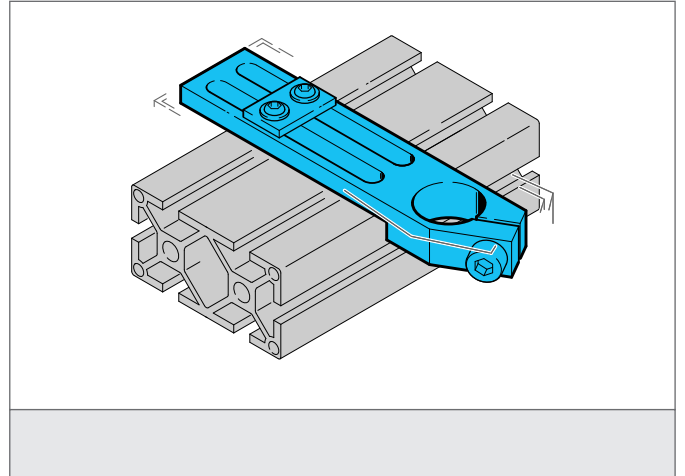

TECHNICAL INFORMATION (typ.)

Size	14 mm (Diameter A) 40 mm (Spacer measure B) 18 mm (Spacer measure C)
Suitable for	Clamping pin 14 mm
Casing material	metal
Product series	System holder SH