

SH-WKA-20-20-150

Bras d'équerrage

- Highly flexible versatile mounting system
- Montage polyvalent
- Réglage lisse
- Conception robuste

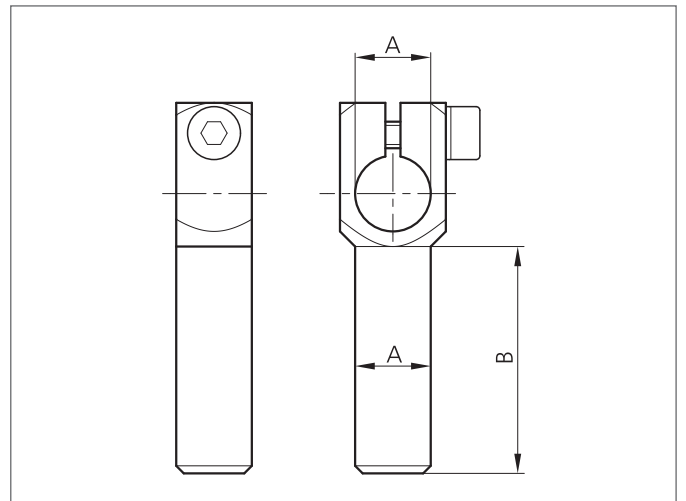
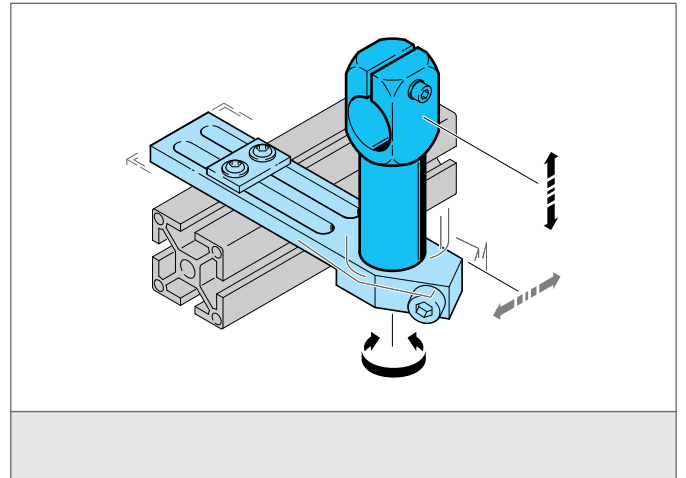

CARACTÉRISTIQUES TECHNIQUES (typ.)

Dimensions	20 mm (Diamètre A) 150 mm (Spacer measure B)
Approprié pour	Clamping pin 20 mm
Matériau du boîtier	Métal
Product series	System holder SH