

# SH-WKA-14-14-40

## Angle arm

- Highly flexible versatile mounting system
- All-purpose mounting
- Smooth adjustment
- Robust design

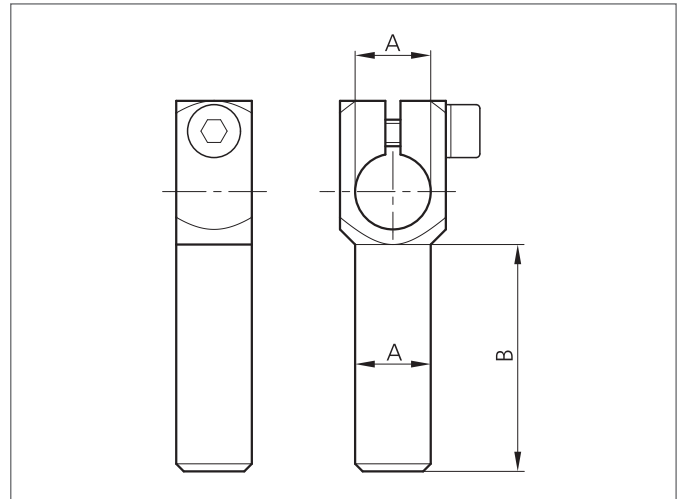
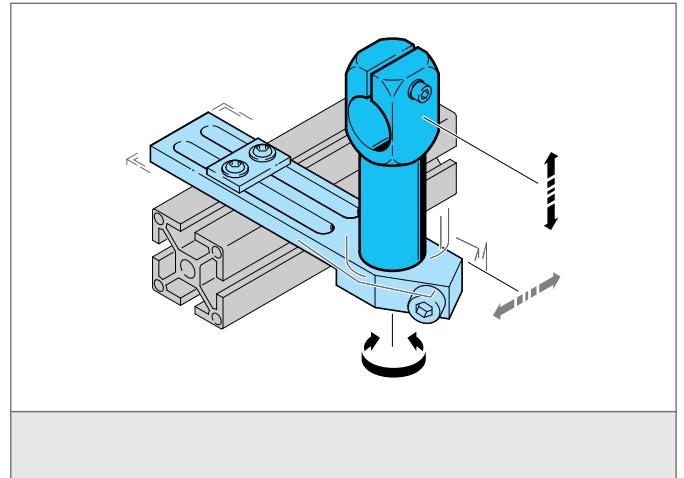

### TECHNICAL INFORMATION (typ.)

Size	14 mm (Diameter A) 40 mm (Spacer measure B)
Suitable for	Clamping pin 14 mm
Casing material	metal
Product series	System holder SH