

SH-WKA-10-10-90

Angle arm

- Highly flexible versatile mounting system
- All-purpose mounting
- Smooth adjustment
- Robust design

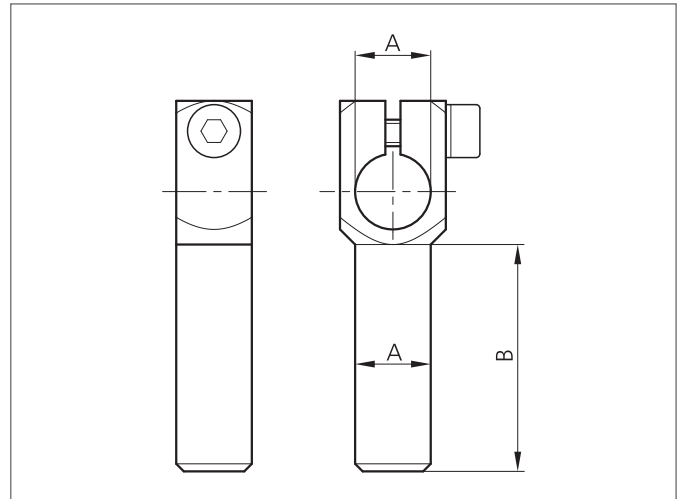
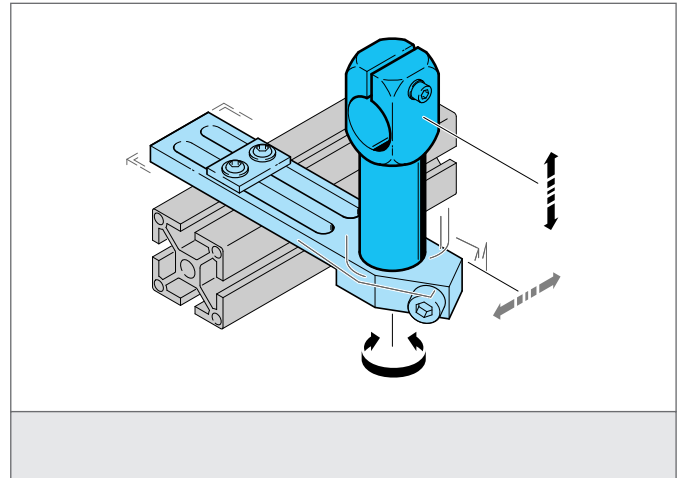

TECHNICAL INFORMATION (typ.)

Size	10 mm (Diameter A) 90 mm (Spacer measure B)
Suitable for	Clamping pin 10 mm
Casing material	metal
Product series	System holder SH