

SH-GLA-14-14-40

Articulated arm

- Highly flexible versatile mounting system
- All-purpose mounting
- Smooth adjustment
- Robust design

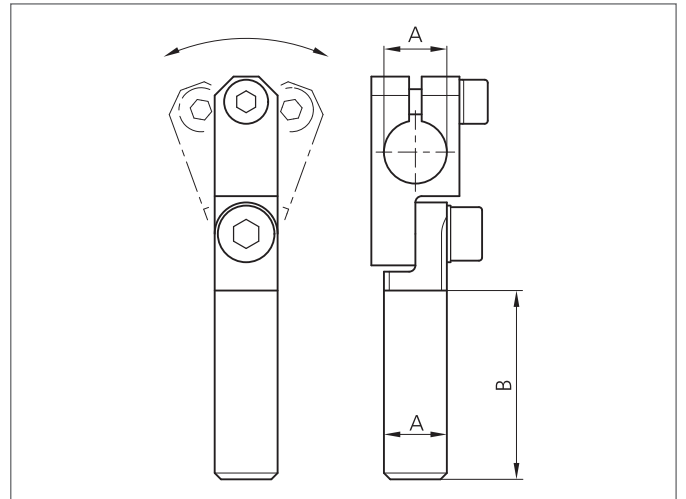
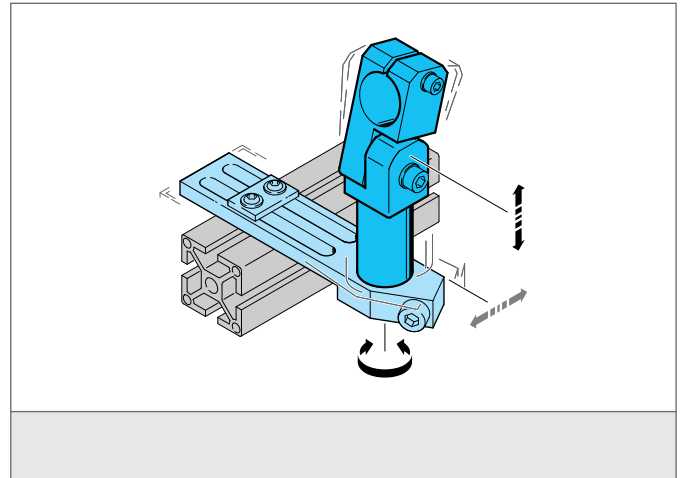

TECHNICAL INFORMATION (typ.)

Size	14 mm (Diameter A) 40 mm (Spacer measure B)
Characteristics	Adjustable
Suitable for	Clamping pin 14 mm
Casing material	metal
Product series	System holder SH