

USGT 60/8 U-B4

Ultrasonic Fork Sensor

- Large linearized analog range
- Very high repeatability
- Web edge control also with transparent materials
- Insensitive to dirt

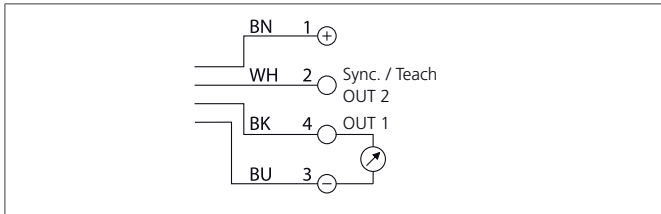

Safety instructions

The Instruments are not to be used for safety applications, in particular applications in which safety of persons depends on proper operation of the instruments.
These instruments shall exclusively be used by qualified personnel.

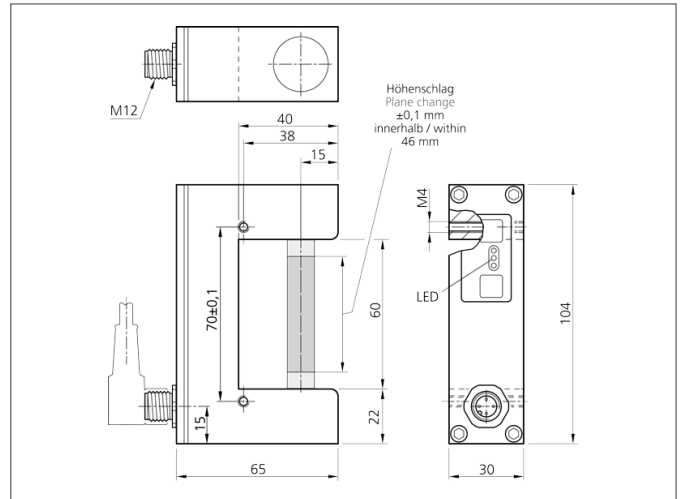

TECHNICAL INFORMATION (typ.)	+20°C, 24V DC
Operating principle	Ultrasonic through beam sensor
Evaluation	analog
Design	fork
Fork width/measuring range	60/8 mm
Service voltage	8 ... 30 V DC
No-load current	35 mA
Sensitivity adjustment	Teach key
Analog output	10 ... 0 V, Load / < 10000 Ω
Ripple	10 %
Shock-/vibration load	10 ... 55 Hz / 1,0 mm / 30 g
Switching frequency	500 Hz
Reproducibility	0,1 mm
Ambient temperature, operation	0 ... +60 °C
Insulation voltage endurance	500 V
Protection class	IP 67
Casing material	Aluminium black anodized
Connection	Connector, M12, 4-poled