

US 60 K 5000 AI-I-TSSL

Ultrasonic Sensor

- Robust casing
- Compact design
- Zero and full scale adjustable
- Scanning range adjustable
- Insensitive to dirt
- Insensitive to ambient noise
- Scanning does not depend on surface
- Analog output
- High follow-up speed
- High resolution
- Piezo-ceramic composite transducer

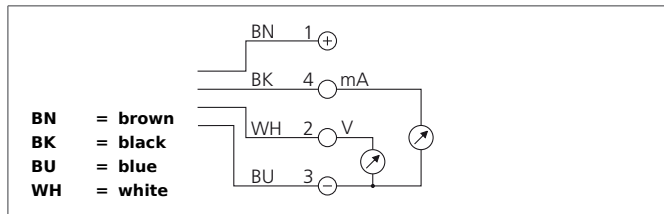

Safety instructions

The Instruments are not to be used for safety applications, in particular applications in which safety of persons depends on proper operation of the instruments.
 These instruments shall exclusively be used by qualified personnel.

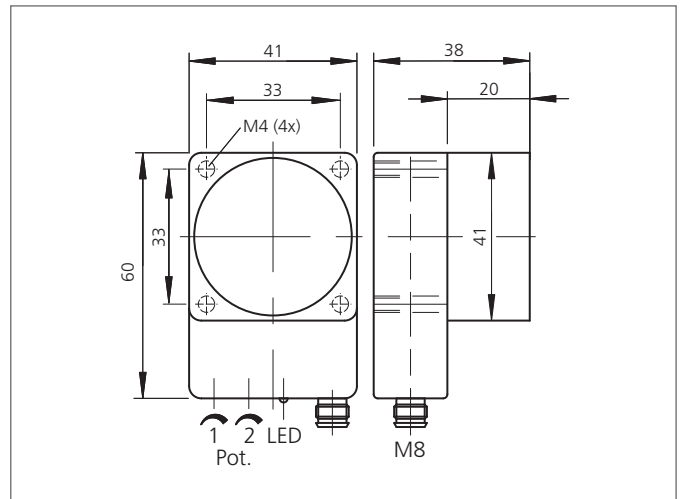

TECHNICAL INFORMATION (typ.)	+20°C, 24V DC
Operating principle	Ultrasonic sensor
Evaluation	analog
Size	60 x 41 x 38 mm (Dimensions)
Design	cuboid design
Service voltage	15 ... 30 V DC
No-load current	85 mA
Operating distance	400 ... 6000 mm
Resolution	0,1 % / Sn max.
Switching output	Analog output (2x)
Analog output	10 ... 0 V, 20 ... 4 mA
Measuring time	2000 ms (95% Sn max.)
Sound frequency	80 kHz
Ripple	20 mV
Linearity analog output	< 0,5 % / Sn max.
Shock-/vibration load	10 ... 55 Hz / 1,0 mm / 30 g
Accuracy	< 1 % / Sn max.
Ambient temperature, operation	-20 ... +50 °C
Temperature drift	1 % (-20 ... +50°C)
Load resistance	> 10000 Ω / < 400 Ω
Insulation voltage endurance	500 V
Protection class	IP 67
Casing material	polyamide
Connection	Connector, M8, 4-poled