

US 60 K 1000 PSI-I-TSSL

Ultrasonic Sensor

- Robust casing
- Compact design
- Scanning range adjustable
- Insensitive to dirt
- Insensitive to ambient noise
- Scanning does not depend on surface
- Switching output and analog output
- High follow-up speed
- High resolution
- Piezo-ceramic composite transducer

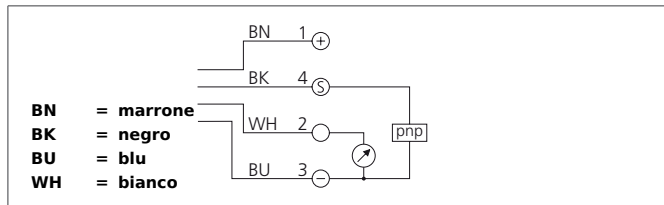

Safety instructions

The Instruments are not to be used for safety applications, in particular applications in which safety of persons depends on proper operation of the instruments.
These instruments shall exclusively be used by qualified personnel.

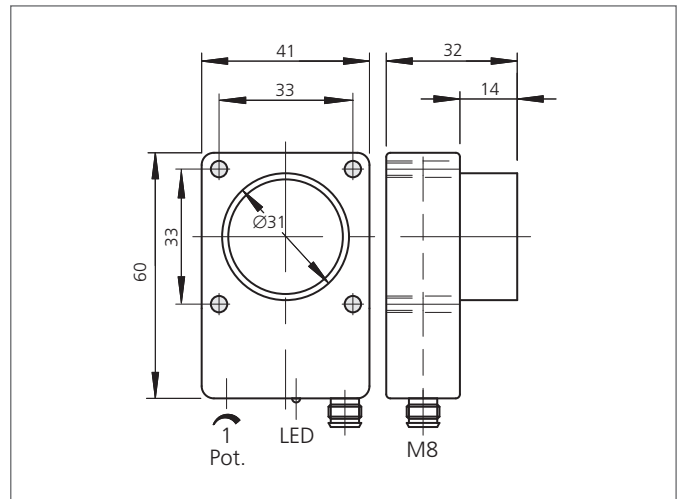

TECHNICAL INFORMATION (typ.)	+20°C, 24V DC
Operating principle	Ultrasonic sensor
Evaluation	digital, analog
Size	60 x 41 x 18 mm (Dimensions)
Design	cuboid design
Service voltage	15 ... 30 V DC
No-load current	80 mA
Operating distance	135 ... 1000 mm
Resolution	0,2 % / Sn max.
Switching output	pnp, 100 mA, NO + analog
Switching hysteresis	25 mm
Analog output	20 ... 4 mA
Measuring time	250 ms (95% Sn max.)
Sound frequency	180 kHz
Ripple	20 mV
Linearity analog output	< 0,5 % / Sn max.
Shock-/vibration load	10 ... 55 Hz / 1,0 mm / 30 g
Switching frequency	5 Hz
Accuracy	< 1 % / Sn max.
Response-/release time	130 ms / 90 ms (50% Sn max.)
Ambient temperature, operation	-20 ... +50 °C
Temperature drift	1 % (-20 ... +50°C)
Load resistance	< 400 Ω
Insulation voltage endurance	500 V

US 60 K 1000 PSI-I-TSSL

Ultrasonic Sensor



TECHNICAL INFORMATION (typ.)	+20°C, 24V DC
Protection class	IP 67
Casing material	polyamide
Connection	Connector, M8, 4-poled