

# US 60 K 2500 PSS-TSSL

## Ultrasonic Sensor

- Robust casing
- Compact design
- Scanning range adjustable
- Insensitive to dirt
- Insensitive to ambient noise
- Scanning does not depend on surface
- Switching output
- High resolution
- Piezo-ceramic composite transducer

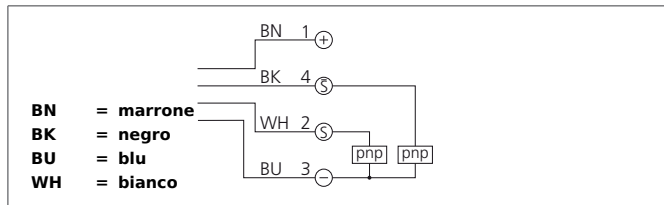

### Safety instructions

The Instruments are not to be used for safety applications, in particular applications in which safety of persons depends on proper operation of the instruments.  
These instruments shall exclusively be used by qualified personnel.

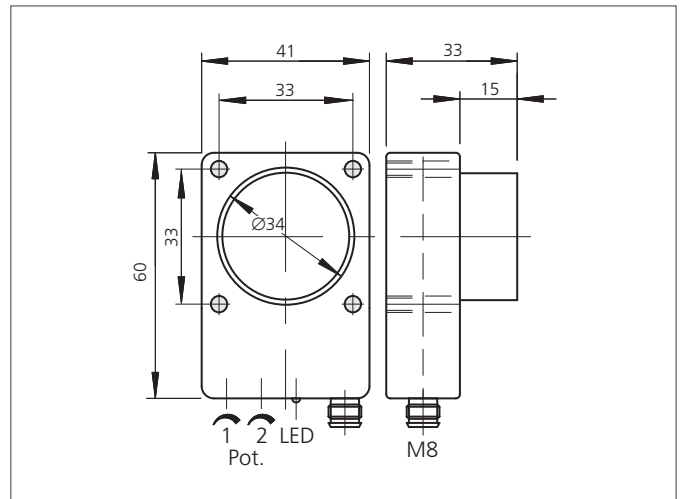

TECHNICAL INFORMATION (typ.)	+20°C, 24V DC
Operating principle	Ultrasonic sensor
Evaluation	digital
Size	60 x 41 x 33 mm (Dimensions)
Design	cuboid design
Service voltage	15 ... 30 V DC
No-load current	< 60 mA
Operating distance	250 ... 2500 mm
Resolution	0,1 % / Sn max.
Switching output	pnp, 100 mA, NO (2x)
Switching hysteresis	40 mm
Sound frequency	120 kHz
Shock-/vibration load	10 ... 55 Hz / 1,0 mm / 30 g
Switching frequency	3 Hz
Accuracy	< 1 % / Sn max.
Response-/release time	200 ms / 120 ms (50% Sn max.)
Ambient temperature, operation	-20 ... +50 °C
Temperature drift	1 % (-20 ... +50°C)
Insulation voltage endurance	500 V
Protection class	IP 67
Casing material	polyamide
Connection	Connector, M8, 4-poled