

LGL 121 P3K-TSSL

Laser Angled Light Barrier

- Very high resolution
- Optical axis approachable in x-, y- and z-direction
- Visible laser spot
- High operating frequency
- Light/dark switching
- Laser class 1
- Bright ring LED
- 5-year warranty



Safety instructions

Inproper use may result in hazardous radiation exposure. Pay attention to accident prevention rules and laser class. The instruments are not to be used for safety applications, in particular applications in which safety of persons depends on proper operation of the instruments. These instruments shall exclusively be used by qualified personnel.

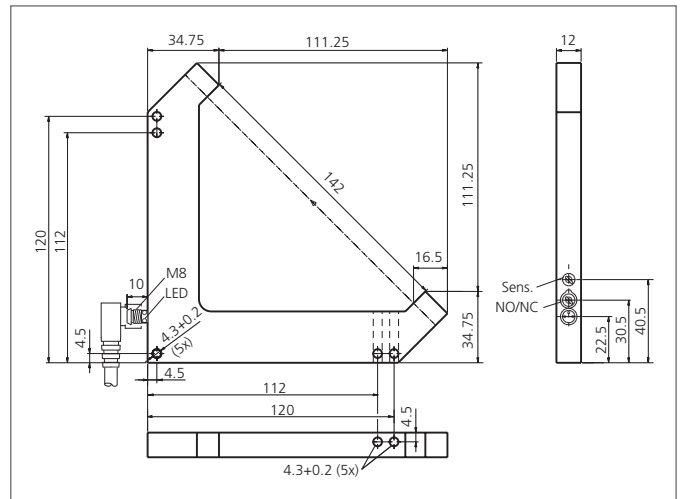

TECHNICAL INFORMATION (typ.)	+20°C, 24V DC
Operating principle	Optical
Evaluation	digital
Size	146 x 146 x 12 mm (Dimensions)
Design	Angle
Branch length inside	120/120 mm
Emitted light	Red light laser, 650 nm, clocked
Laser class	1 (IEC 60825-1)
Service voltage	10 ... 35 V DC (Supply Class 2)
No-load current	< 30 mA
Operating distance	142 mm (optical axis)
Resolution	0,05 mm
Sensitivity adjustment	potentiometer
Switching output	pnp, 200 mA, NO/NC, switchable
Switching hysteresis	< 20 µm
Shock-/vibration load	10 ... 55 Hz / 1,0 mm / 30 g
Voltage drop	< 2,8 V
Switching frequency	3000 Hz
Reproducibility	10 µm
Laser power	< 100 µW
Ambient temperature, operation	+5 ... +45 °C
Ambient light immunity	100 kLx
Insulation voltage endurance	250 V
Protection class	IP 67

LGL 121 P3K-TSSL

Laser Angled Light Barrier



TECHNICAL INFORMATION (typ.)	+20°C, 24V DC
Protection degree	III, operation on protective low voltage
Casing material	Aluminium black anodized
Connection	Connector, M8, 3-poled
Connecting cable	TK ...
Mountable side by side	Yes