

DCC 6.5 V 02 PSK-TSL/29

Inductive Proximity Switch

- Metal plug
- Integrated amplifier
- Short-circuit protection
- Starting pulse suppression
- LED

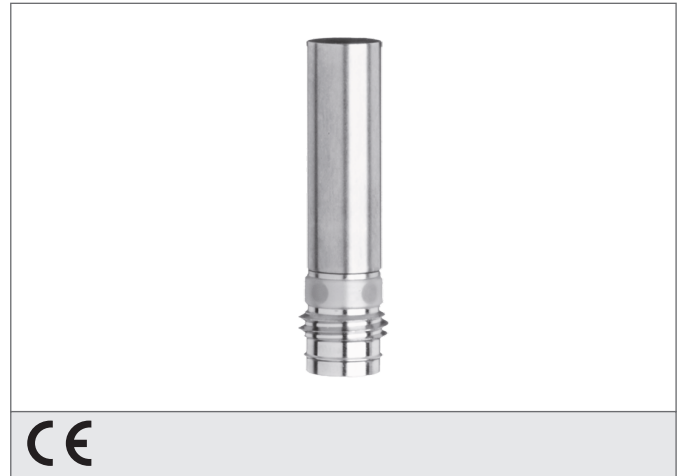

Safety instructions

The Instruments are not to be used for safety applications, in particular applications in which safety of persons depends on proper operation of the instruments.

These instruments shall exclusively be used by qualified personnel.

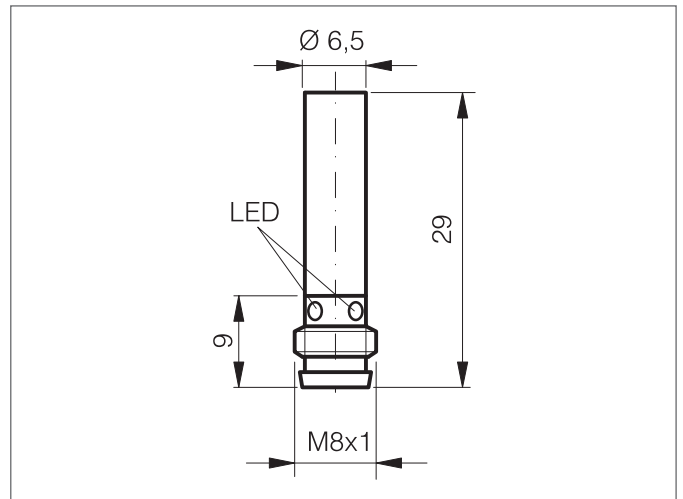

TECHNICAL INFORMATION (typ.)	+20°C, 24V DC
Operating principle	Inductive
Evaluation	digital
Size	Ø 6,5 mm (Diameter)
Design	cylinder
Mounting	flush
Characteristics	increased operating distance
Operating distance	2 mm
Standardized measuring plate	6,5 x 6,5 x 1 mm
Service voltage	10 ... 30 V DC
No-load current	< 10 mA
Switching output	pnp, 200 mA, NO
Switching hysteresis	5 %
Shock-/vibration load	10 ... 55 Hz / 1,0 mm / 30 g
Voltage drop	< 2,0 V
Switching frequency	3000 Hz
Ambient temperature, operation	-25 ... +70 °C
Insulation voltage endurance	500 V
Protection class	IP 67
Casing material	stainless steel
Connection	Connector, M8