

DCC 18 M 20 PSK-IBSL

Inductive Proximity Switch

- Metal plug
- Integrated amplifier
- Short-circuit protection
- Starting pulse suppression
- LED



Safety instructions

The Instruments are not to be used for safety applications, in particular applications in which safety of persons depends on proper operation of the instruments.

These instruments shall exclusively be used by qualified personnel.

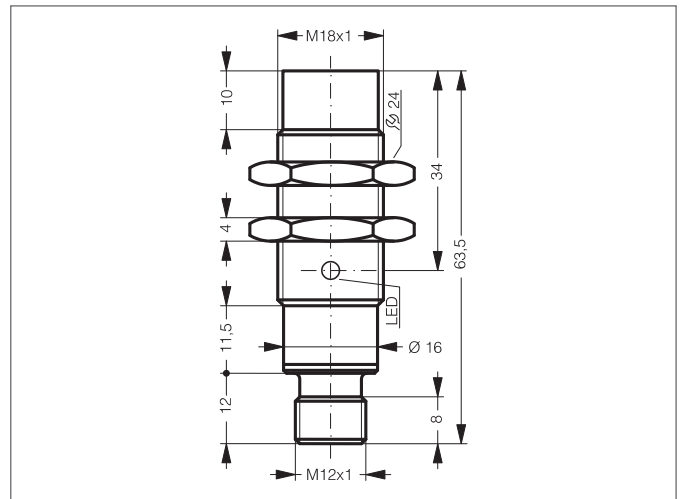

TECHNICAL INFORMATION (typ.)		+20°C, 24V DC
Operating principle		Inductive
Evaluation		digital
Size		M18 x 1 (thread)
Design		screw
Mounting		non-flush
Characteristics		extremely high operating distance
Operating distance		20 mm
Standardized measuring plate		60 x 60 x 1 mm
Service voltage		10 ... 30 V DC
No-load current		< 10 mA
Switching output		pnp, 200 mA, NO
Switching hysteresis		5 %
Shock-/vibration load		10 ... 55 Hz / 1,0 mm / 30 g
Voltage drop		< 2,0 V
Switching frequency		200 Hz
Ambient temperature, operation		-25 ... +70 °C
Insulation voltage endurance		500 V
Protection class		IP 67
Casing material		brass nickel plated
Connection		Connector, M12