

KSSTI 600 FG3K-TSSL Capacitive Label Sensor

- Detection of transparent labels, double layers, bonding points, cracking points etc.
- Sensitivity adjustment via teach key
- Auto-teach during a running process
- Remote teach option with key-lock function
- Temperature and air humidity compensation
- Static functional principle
- Separated housing

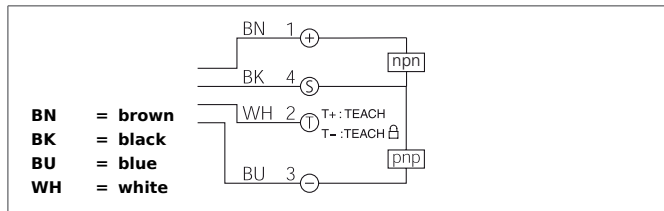

Safety instructions

The Instruments are not to be used for safety applications, in particular applications in which safety of persons depends on proper operation of the instruments.
These instruments shall exclusively be used by qualified personnel.

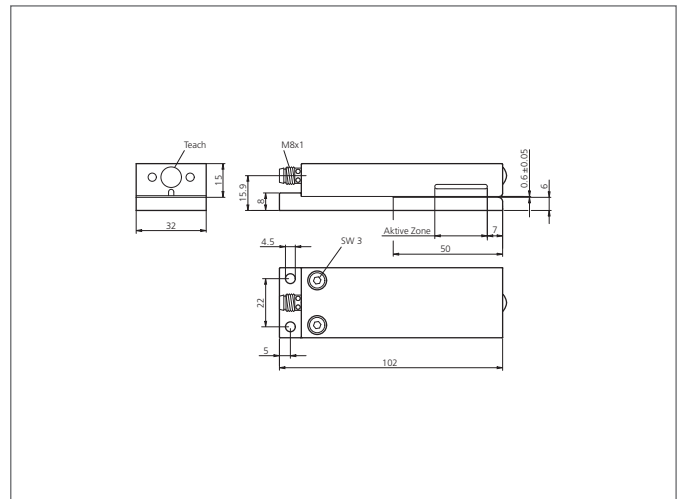

TECHNICAL INFORMATION (typ.)	+20°C, 24V DC
Operating principle	Capacitive
Fork opening	0,6 mm
Branch length inside	50 mm
Service voltage	10 ... 35 V DC
No-load current	< 70 mA
Sensitivity adjustment	Teach key + remote teach
Switching output	Push pull, 200 mA, NO/NC, switchable
Switching hysteresis	material dependent
Label length	> 2 mm
Label interspace	> 2 mm
Label thickness	< 0,5 mm
Tape speed	< 500 m/min
Voltage drop	< 2,5 V
Readiness delay	< 150 ms
Ambient temperature, operation	0 ... +60 °C
Insulation voltage endurance	500 V
Protection class	IP 65
Casing material	Aluminium black anodized
Connection	Connector, M8, 4-poled
Connecting cable	TK ... /4