

SB-RGB-911-K-B5

Iluminación de señal

- High light intensity thanks to most modern, highly efficient LEDs
- Easy operation even without IO-Link possible
- Per IO-Link free parameterizable functions
- Larga vida útil gracias al control térmico inteligente
- Large light field for an optimal display of the machine status
- Can be used immediately by 3 color pre-sets: red - green - yellow
- Elevado grado de protección IP67
- Dispositivo de soporte magnético disponible
- Adjustable Mounting Bracket available as an option
- Attachable Diffusion filter available as an option

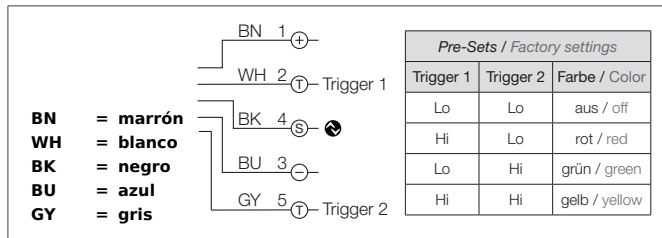

Safety instructions

The Instruments are not to be used for safety applications, in particular applications in which safety of persons depends on proper operation of the instruments.
 These instruments shall exclusively be used by qualified personnel.

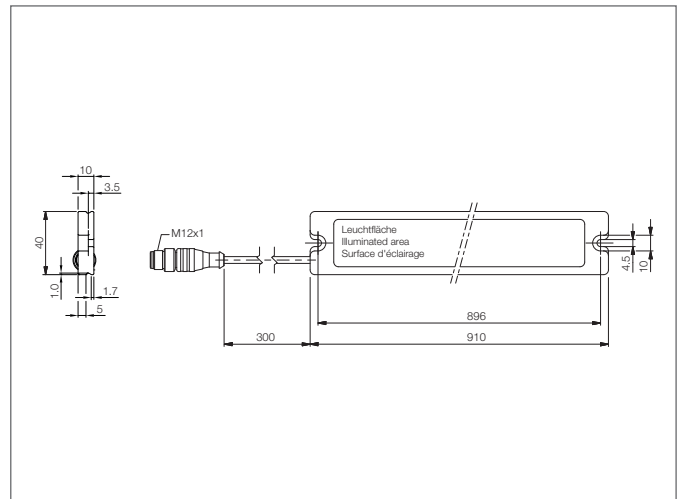

TECHNICAL INFORMATION (typ.)	+20°C, 24V DC
Operating modes	constant, blink, flash
Área iluminada	30 x 870 mm
Color de la luz	RGB + custom
Ángulo de emisión FWHM	120°
Tensión de alimentación	24 V DC ± 5%, (suministro clase 2)
Corriente en vacío	745 mA RMS / 1.400 mA Peak, (24 V DC)
Entrada de trigger nivel bajo	< 5,0 V
Entrada de trigger nivel alto	> 8,0 V
Entrada de trigger	3 color pre-sets: selectable by Trigger 1 + 2
Interface	IO-Link, V1.1, COM2 (38,4kBd), 2300 μs, for parameterization
Potencia	17,8 W (24 V DC)
Protección a la inversión de polaridad	Sí
Temperatura ambiente, operación	0 ... +40 °C
Técnica de protección	IP 67
Grado de protección	III, funcionamiento en bajo voltaje
Grupo de riesgo (DIN EN 62471)	Grupo libre
material de la carcasa	Aluminio nature anodizado
Material	PU, cristal transparente (Ventana)
Conexión	Cable, 0,3 m, with connector, M12, 5-polos
Intensidad de la luz ajustable	10 ... 100%, by IO-Link
Peso	700 g
Cable de conexión	VK ... /5
Cable length max.	5.0 m, (5 x 0.34 mm ² / 24.0 V DC)