

# DCC 12 VHD 2 PS-B3-56-4

## Inductive Proximity Switch

- High-pressure resistant version up to 500 bar
- High-temperature resistant up to 100 °C permanent temperature
- Housing and sensing face made of stainless steel
- Integrated amplifier
- Short-circuit protection
- Starting pulse suppression



### Safety instructions

The Instruments are not to be used for safety applications, in particular applications in which safety of persons depends on proper operation of the instruments.

These instruments shall exclusively be used by qualified personnel.

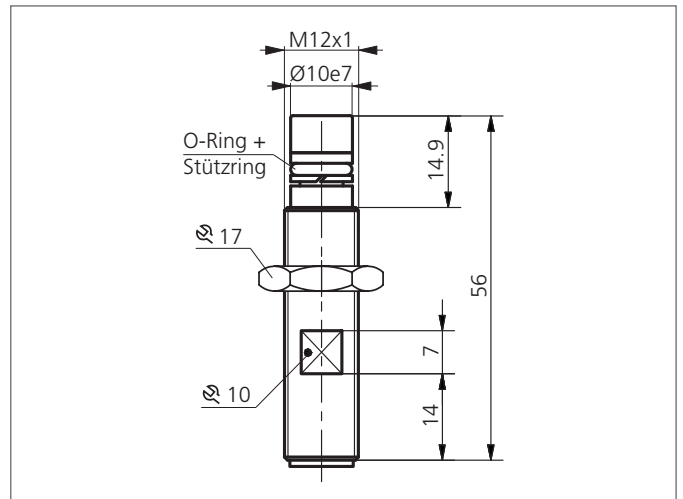

TECHNICAL INFORMATION (typ.)	+20°C, 24V DC
Operating principle	Inductive
Evaluation	digital
Size	M12 x 1 (thread)
Design	screw
Mounting	flush
Characteristics	up to 500 bar, high-pressure resistant
Operating distance	2 mm
Standardized measuring plate	10 x 10 x 1 mm
Service voltage	10 ... 30 V DC
No-load current	< 10 mA
Switching output	pnp, 200 mA, NO
Switching hysteresis	15 %
Shock-/vibration load	10 ... 55 Hz / 1,0 mm / 30 g
Voltage drop	< 2,4 V
Switching frequency	400 Hz
Ambient temperature, operation	-25 ... +100 °C
Insulation voltage endurance	500 V
Protection class	IP 68, IP 69K
Casing material	stainless steel V2A (1.4301 / AISI 304)
Connection	Connector, M12