

DCC 18 M 08 NOLK

Inductive Proximity Switch

- Cable, highly flexible
- Integrated amplifier
- Short-circuit protection
- Starting pulse suppression
- LED

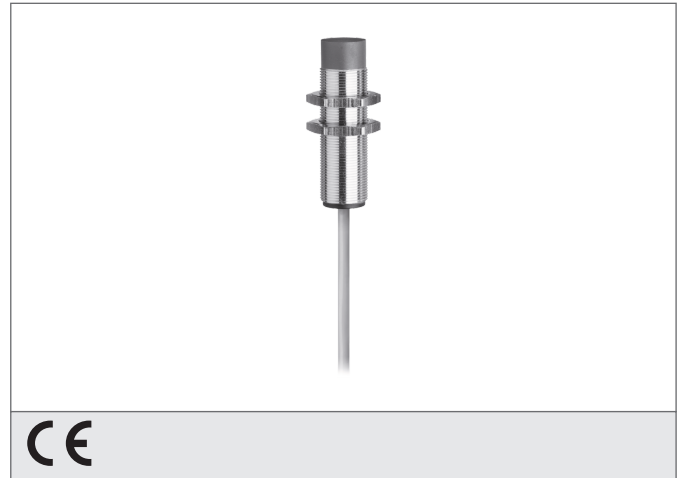

Safety instructions

The Instruments are not to be used for safety applications, in particular applications in which safety of persons depends on proper operation of the instruments.

These instruments shall exclusively be used by qualified personnel.

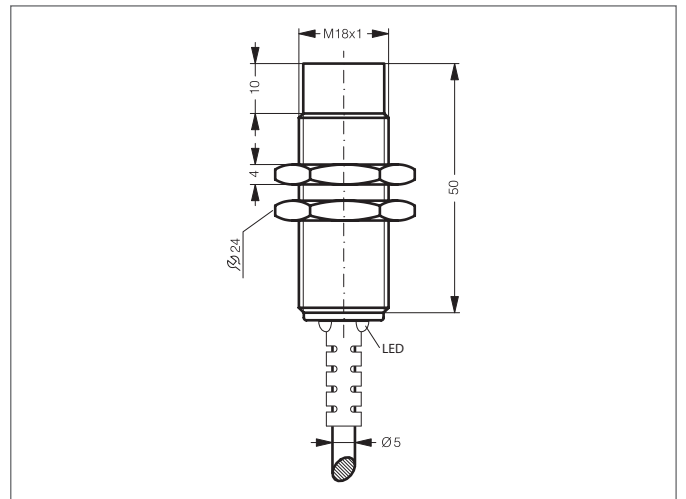

TECHNICAL INFORMATION (typ.)	+20°C, 24V DC
Operating principle	Inductive
Evaluation	digital
Size	M18 x 1 (thread)
Design	screw
Mounting	non-flush
Operating distance	8 mm
Standardized measuring plate	24 x 24 x 1 mm
Service voltage	10 ... 30 V DC
No-load current	< 10 mA
Switching output	npn, 200 mA, NC
Switching hysteresis	10 %
Shock-/vibration load	10 ... 55 Hz / 1,0 mm / 30 g
Voltage drop	< 2,0 V
Switching frequency	1400 Hz
Ambient temperature, operation	-25 ... +70 °C
Insulation voltage endurance	500 V
Protection class	IP 67
Casing material	brass
Material	PVC (Cable)
Connection	Cable, 2,0 m