

# OTZ 520

## Probe

- Small metal probe
- Detection of metallic and non-metallic parts
- No lateral sensitivity, mountable at or on metal plates

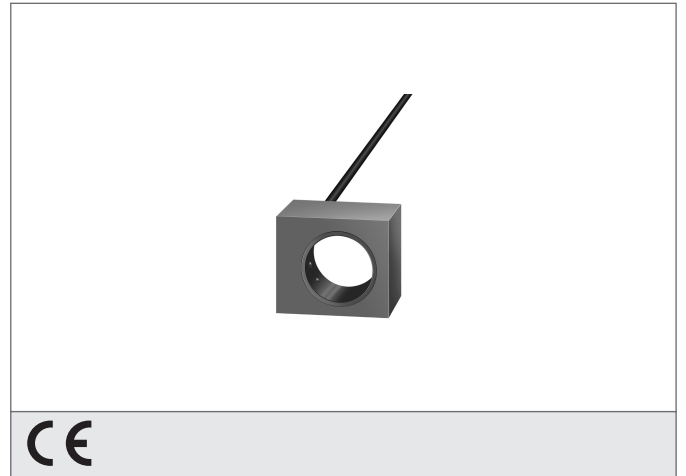

### Safety instructions

The Instruments are not to be used for safety applications, in particular applications in which safety of persons depends on proper operation of the instruments.  
These instruments shall exclusively be used by qualified personnel.

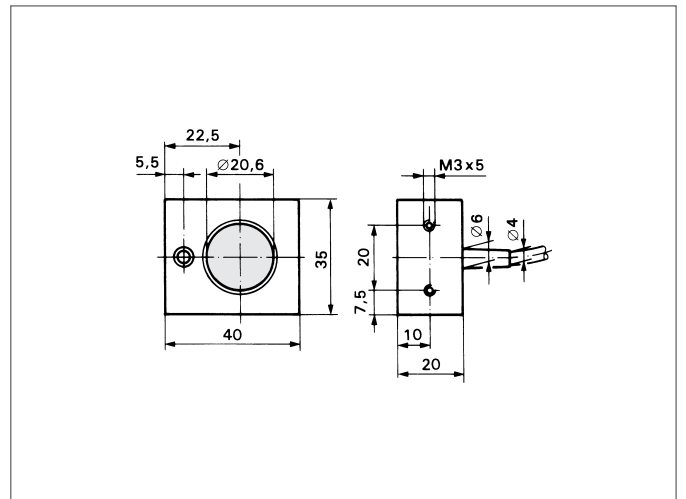

TECHNICAL INFORMATION (typ.)	+20°C, 24V DC
Operating principle	Optical
Design	cuboid design
Inside diameter	20,6 mm
Resolution	Ø 1,0 mm (at the centre)
Shock-/vibration load	10 ... 55 Hz / 1,0 mm / 30 g
Ambient temperature, operation	0 ... +50 °C
Insulation voltage endurance	500 V
Protection class	IP 63
Casing material	Aluminium black anodized
Connection	Cable, 0,5 m, /connector