

IRD 100 PSOK-IBS

Inductive Ring Sensor

- High resolution
- Short response time
- Sensitivity and pulse stretching adjustable
- Insensitive to dirt
- Dynamic operating principle
- Metal connector
- High protection class

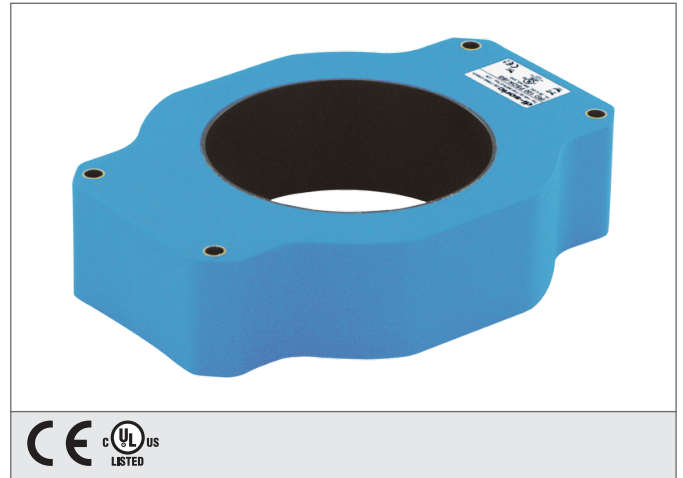

Safety instructions

The Instruments are not to be used for safety applications, in particular applications in which safety of persons depends on proper operation of the instruments.

These instruments shall exclusively be used by qualified personnel.

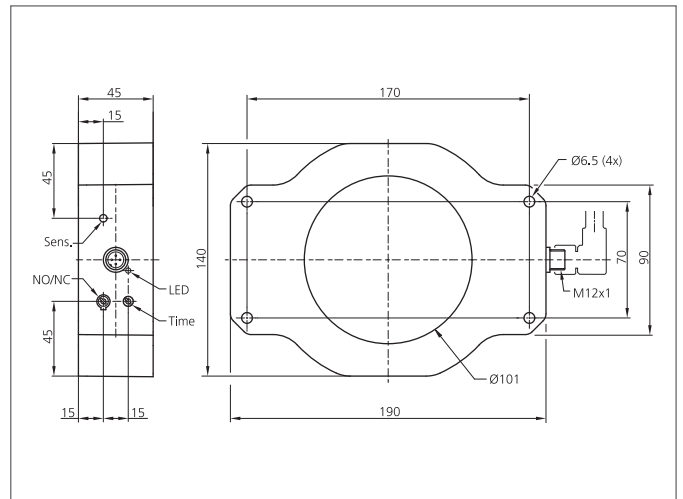

TECHNICAL INFORMATION (typ.)	+20°C, 24V DC
Operating principle	Dynamic
Inside diameter	101 mm
Service voltage	10 ... 35 V DC (Supply Class 2)
No-load current	< 20 mA
Resolution	Ø 5,0 mm
Sensitivity adjustment	potentiometer
Mounting distance to metal	> 30 mm
Switching output	pnp, 200 mA, NO/NC, switchable
Shock-/vibration load	10 ... 55 Hz / 1,0 mm / 30 g
Speed of parts	< 25 m/s
Minimum parts speed	0,1 m/s
Pulse stretching	0,1 ... 150 ms adjustable
Voltage drop	< 2,0 V
Response-/release time	0,20 ms / 0,20 ms
Ambient temperature, operation	-25 ... +70 °C
Insulation voltage endurance	1.000 V
Protection class	IP 67
Protection degree	III, operation on protective low voltage
Casing material	polyamide / ring POM
Connection	Connector, M12, 4-poled
Connecting cable	VK ...