

DCC 12 VL 06 PSLK

Inductive Proximity Switch

- For food industry
- For seawater applications
- Large sensing range to steel and aluminium
- One-piece stainless steel housing
- Protection class IP 68 and IP 69K
- Connecting cable made of TPE-S
- Integrated amplifier
- Short-circuit protection
- Starting pulse suppression
- LED

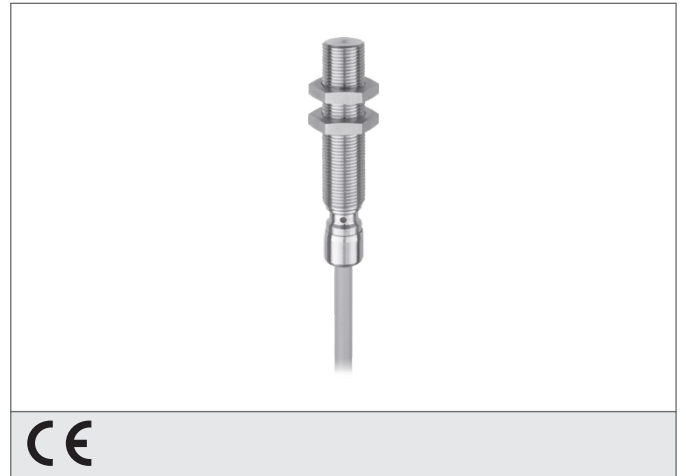

Safety instructions

The Instruments are not to be used for safety applications, in particular applications in which safety of persons depends on proper operation of the instruments.

These instruments shall exclusively be used by qualified personnel.

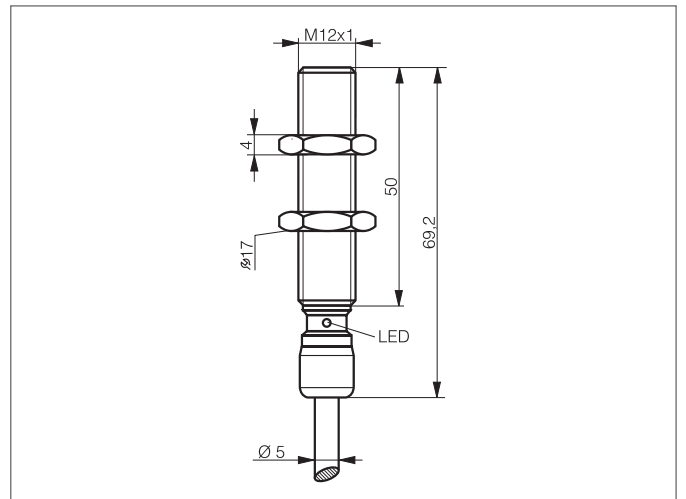

TECHNICAL INFORMATION (typ.)	+20°C, 24V DC
Operating principle	Inductive
Evaluation	digital
Size	M12 x 1 (thread)
Design	screw
Mounting	flush
Characteristics	extremely high operating distance, up to 80 bar, All stainless steel housing
Operating distance	6 mm
Standardized measuring plate	18 x 18 x 1 mm
Service voltage	10 ... 30 V DC
No-load current	< 10 mA
Switching output	pnp, 200 mA, NO
Switching hysteresis	< 15 %
Shock-/vibration load	10 ... 55 Hz / 1,0 mm / 30 g
Voltage drop	< 2,0 V
Switching frequency	600 Hz
Ambient temperature, operation	-25 ... +85 °C
Insulation voltage endurance	500 V
Protection class	IP 68, IP 69K
Casing material	stainless steel (1.4435 / AISI 316L)
Material	TPE-S (Cable)
Connection	Cable, 2,0 m