

- 金属插头
- 集成的放大器
- 防止短路
- 启动脉冲抑制
- LED

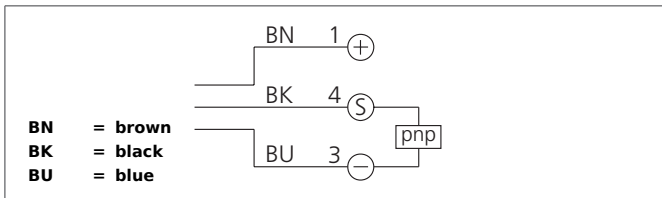

Safety instructions

The Instruments are not to be used for safety applications, in particular applications in which safety of persons depends on proper operation of the instruments.
 These instruments shall exclusively be used by qualified personnel.

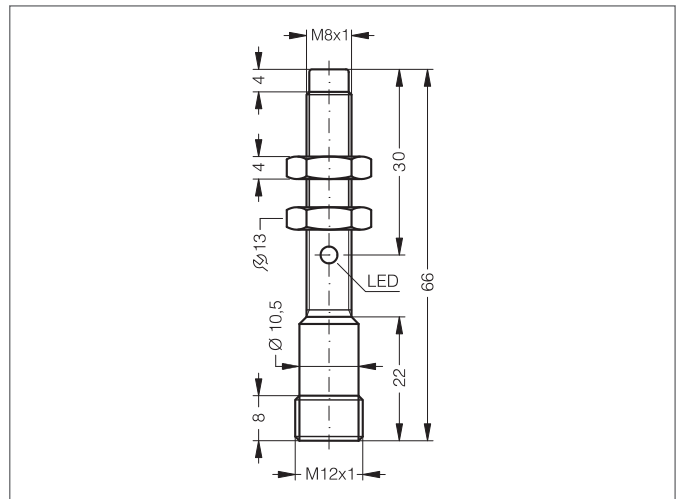

TECHNICAL INFORMATION (typ.)		+20°C, 24V DC
操作原理		电感式
评估		数字的
尺寸		M8 x 1 (thread)
设计		螺纹设计
安装		非齐平
特征		极其高的工作距离
工作距离		6 mm
标准化的测量板		18 x 18 x 1 mm
工作电压		10 ... 30 V DC
内部功耗		< 10 mA
开关输出		pnp, 200 mA, NO
开关滞后		5 %
负载振荡		10 ... 55 Hz / 1,0 mm / 30 g
压降		< 2,0 V
工作频率		500 Hz
环境温度		-25 +70 ° C
绝缘电压		500 V
防护等级		IP 67
外壳材料		brass nickel plated
连接		Connector, M12