

## OEP 12 V 5000 G1L-5M

### High Performance Photoelectric Sensor, Receiver

- Operating distances up to 5 m
- Integrated amplifier electronics
- Transistor output with push-pull
- High functional reserve
- Extremely dirt-resistant
- Easy adjustment
- Different designs to be combined
- High protection class
- Compact design

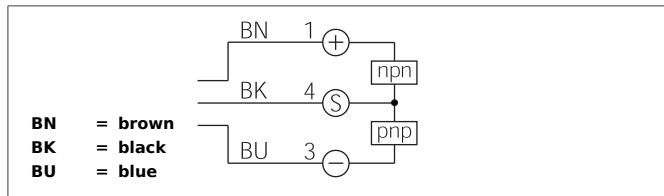
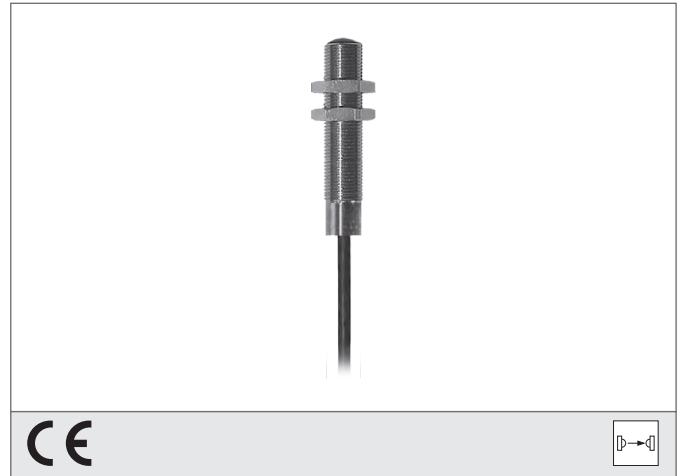

#### Safety instructions

The Instruments are not to be used for safety applications, in particular applications in which safety of persons depends on proper operation of the instruments.

These instruments shall exclusively be used by qualified personnel.

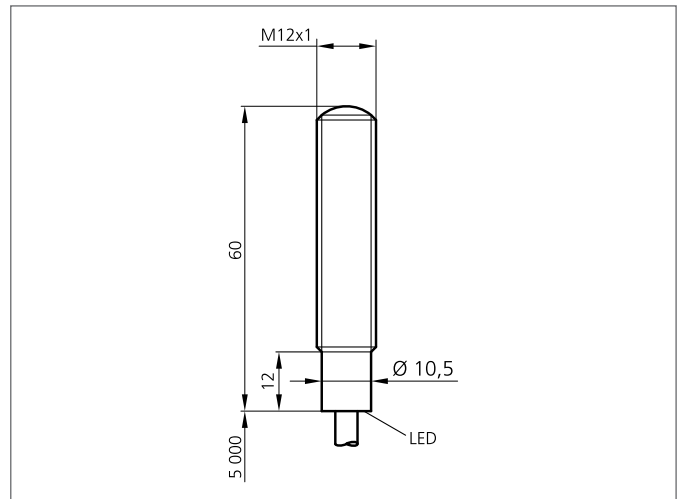

TECHNICAL INFORMATION (typ.)	+20°C, 24V DC
Operating principle	Through beam sensors, receiver, switching output
Evaluation	digital
Size	M12 x 1 (thread)
Design	screw
Characteristics	High transmit power and dirt penetration
Service voltage	10 ... 35 V DC
No-load current	< 40 mA
Operating distance	0 ... 5000 mm dependent on the transmitter
Sensitivity adjustment	no setting elements
Switching output	Push pull, 200 mA, NC (pnp) / NO (npn)
Shock-/vibration load	10 ... 55 Hz / 1,0 mm / 30 g
Switching frequency	500 Hz
Ambient temperature, operation	-20 ... +60 °C
Ambient light immunity	15 kLx, Sunlight, 2 kLx, clocked light
Protection class	IP 67, IP 68, IP 69K
Protection degree	III, operation on protective low voltage
Casing material	stainless steel V2A (1.4301 / AISI 304)
Material	PVC (Cable)
Connection	Cable, 5,0 m