

ORVTI 51 M 5000 P3K-TSSL

Retroreflective Sensor

- Red light
- Polarized filter
- Teach function
- High operating frequency
- Bright ring LED
- Light/dark switching
- Functional reserve indicator/contamination indicator
- Robust metal casing



Safety instructions

The Instruments are not to be used for safety applications, in particular applications in which safety of persons depends on proper operation of the instruments.
These instruments shall exclusively be used by qualified personnel.

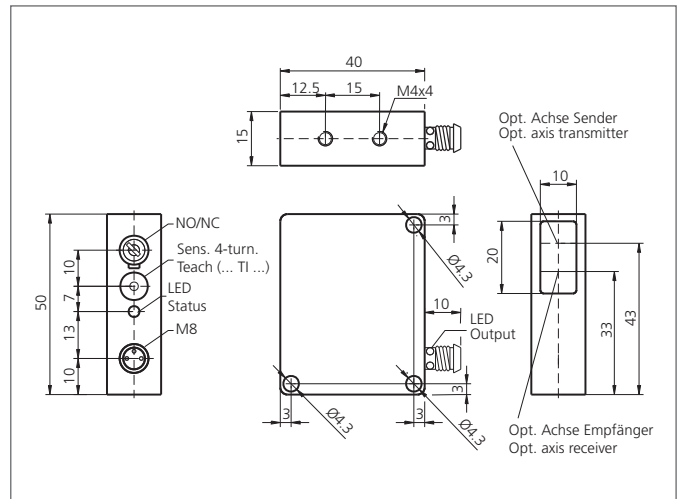

TECHNICAL INFORMATION (typ.)		+20°C, 24V DC
Operating principle		Retroreflective sensor
Evaluation		digital
Size		50 x 40 x 15 mm (Dimensions)
Design		cuboid design
Characteristics		Integrated polarized filter
Emitted light		Red, 660 nm, clocked
Operating distance		300 ... 5000 mm adjustable
Service voltage		10 ... 35 V DC
No-load current		< 40 mA
Sensitivity adjustment		Teach key
Referring reflector		100 x 100 mm
Switching output		pnp, 200 mA, NO/NC, switchable
Shock-/vibration load		10 ... 55 Hz / 1,0 mm / 30 g
Voltage drop		< 2,0 V
Switching frequency		1000 Hz
Response-/release time		0,50 ms / 0,50 ms
Ambient temperature, operation		-10 ... +60 °C
Ambient light immunity		20 kLx
Insulation voltage endurance		500 V
Protection class		IP 67
Protection degree		III, operation on protective low voltage
Casing material		Die-cast zinc black lacquered finish
Material		polymethyl methacrylate (Window)

ORVTI 51 M 5000 P3K-TSSL
Retroreflective Sensor



TECHNICAL INFORMATION (typ.)

Connection

+20°C, 24V DC

Connector, M8, 3-poled