

BE 1-A240-G2-K-BS

Barlight

- Very compact design
- Homogenous luminous field
- Cable outlet at the front or back side usable
- Universal mounting possibility
- Metal casing
- Homogenous illumination
- High efficiency
- Robust metal casing

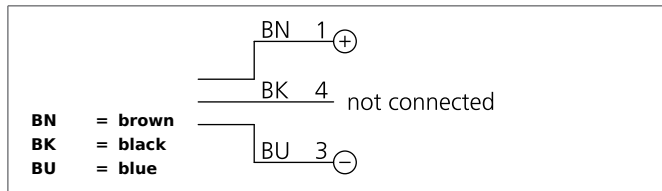

Safety instructions

The Instruments are not to be used for safety applications, in particular applications in which safety of persons depends on proper operation of the instruments.

These instruments shall exclusively be used by qualified personnel.

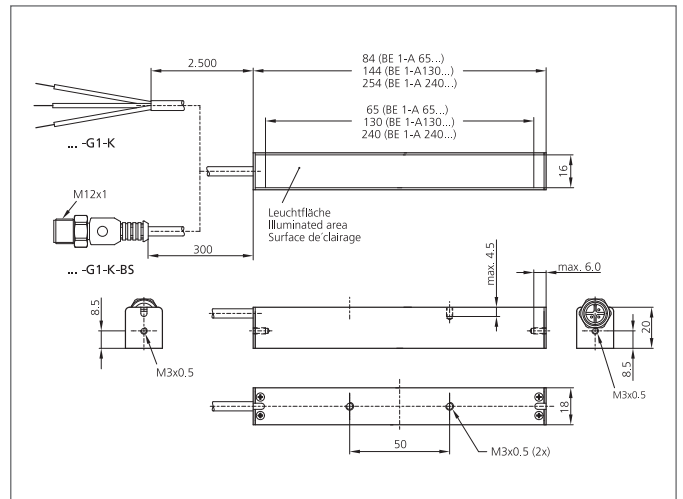

TECHNICAL INFORMATION (typ.)	+20°C, 24V DC
Design	Barlight
Illuminated area	240 mm
Light colour	Green, 525 nm
Emission angle FWHM	40°
Illumination intensity	11.0 klx (0.1 m), 4.5 klx (0.2 m), 1.0 klx (0.5 m)
Service voltage	24 V DC (Supply Class 2)
No-load current	310 mA, (24 V DC)
Power	7,3 W (24 V DC)
Shock-/vibration load	10 ... 55 Hz / 1,0 mm / 30 g
Ambient temperature, operation	0 ... +40 °C
Protection class	IP 20
Protection degree	III, operation on protective low voltage
Risk group (DIN EN 62471)	Free group
Casing material	Aluminium anodized
Material	PUR (Cable)
Connection	Cable, 0,3 m, M12
Connecting cable	VK ...