

BE-R70-F5-K-POL

Ringlight for flash controller

- High excess current factor
- Pulsed mode for inspection of fast moving objects
- Extremely powerful light for high depth of field
- Long-life thanks to intelligent thermal management
- Homogenous luminous field
- High protection class IP 67
- Robust metal casing

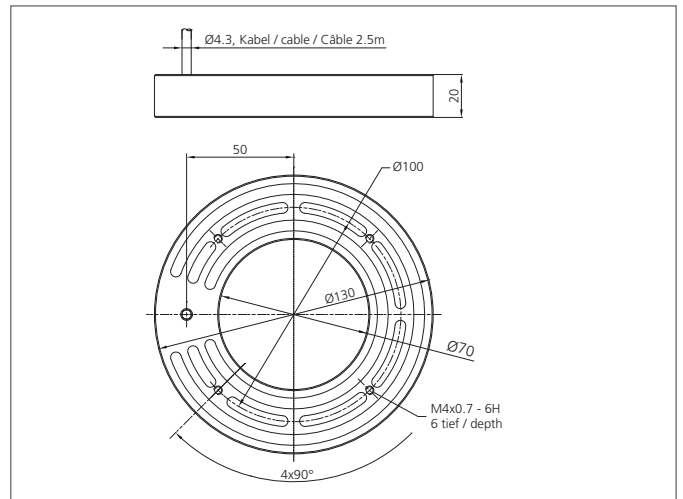
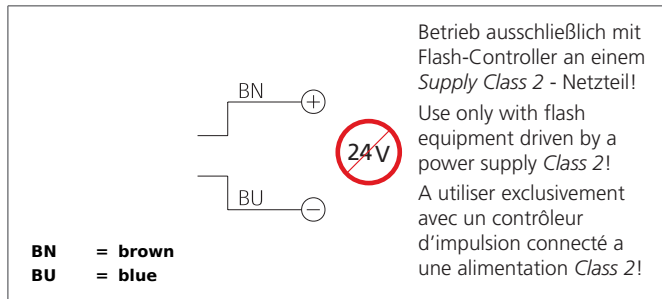
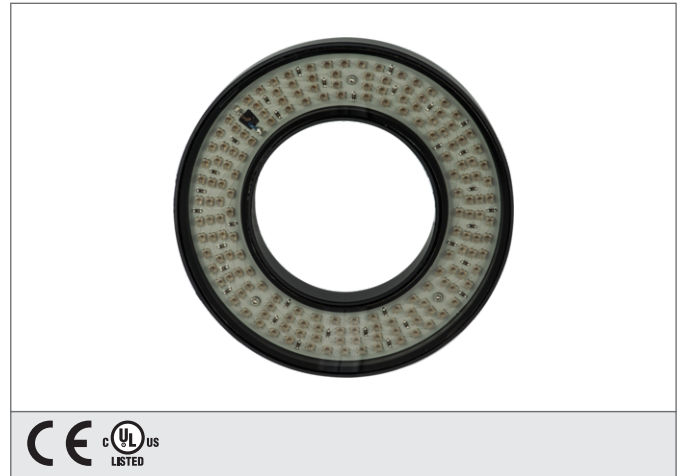

Safety instructions

The Instruments are not to be used for safety applications, in particular applications in which safety of persons depends on proper operation of the instruments.
These instruments shall exclusively be used by qualified personnel.

TECHNICAL INFORMATION (typ.)	+20°C, 24V DC
Pulse power consumption (max)	140 W
Pulse overload factor	10
Pulse current capacity	6000 mA
Size	Ø 70 mm, Ø 130 mm (Diameter) 20 mm (Height)
Design	Ringlight
Characteristics	Flashable by means of flash controller
Light colour	White, polarised, 6500 K
Emission angle FWHM	120°
Illumination intensity	2.0 klx (0.2 m / 100%) 6.7 klx (0.2 m / 500%) 11.2 klx (0.2 m / 1000%) 380 Lux (0.5 m / 100%) 1.2 klx (0.5 m / 500%) 1.8 klx (0.5 m / 1000%)
Service voltage	No constant voltage!
Shock-/vibration load	10 ... 55 Hz / 1,0 mm / 30 g
Inverse polarity protection	Yes
Ambient temperature, operation	0 ... +40 °C
Insulation voltage endurance	500 V
Protection class	IP 67
Risk group (DIN EN 62471)	Free group
Casing material	Aluminium black anodized
Material	PUR (Cable) PMMA, polarized (Protection optics)

BE-R70-F5-K-POL
Ringlight for flash controller



TECHNICAL INFORMATION (typ.)

Connection

+20°C, 24V DC

Cable, 2,5 m, flying leads, Use only with flash equipment!