

OEPQ 12 M 20000 G2L-5M

High Performance Photoelectric Sensor, Receiver

- Operating distances up to 20 m
- Integrated amplifier electronics
- Transistor output with push-pull
- High functional reserve
- Extremely dirt-resistant
- Easy adjustment
- Different designs to be combined
- High protection class
- Compact design

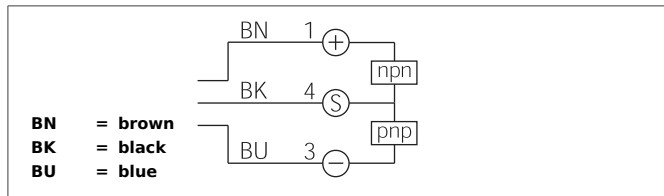
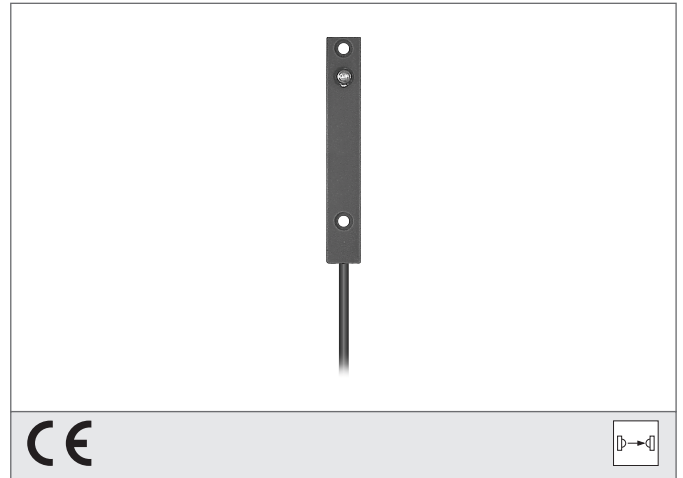

Safety instructions

The Instruments are not to be used for safety applications, in particular applications in which safety of persons depends on proper operation of the instruments.

These instruments shall exclusively be used by qualified personnel.

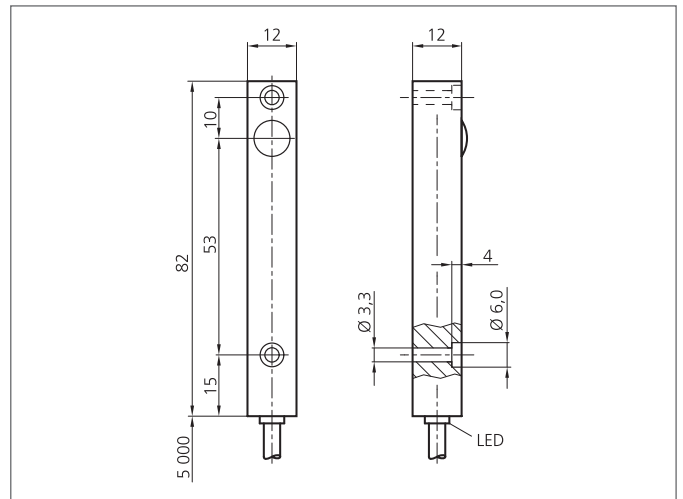

TECHNICAL INFORMATION (typ.)	+20°C, 24V DC
Operating principle	Through beam sensors, receiver, switching output
Evaluation	digital
Size	82 x 12 x 12 mm (Dimensions)
Design	cuboid design
Characteristics	High transmit power and dirt penetration
Service voltage	10 ... 35 V DC
No-load current	< 40 mA
Operating distance	0 ... 20000 mm dependent on the transmitter
Sensitivity adjustment	no setting elements
Switching output	Push pull, 200 mA, NO
Shock-/vibration load	10 ... 55 Hz / 1,0 mm / 30 g
Switching frequency	150 Hz
Ambient temperature, operation	-20 ... +60 °C
Ambient light immunity	15 kLx, Sunlight, 2 kLx, clocked light
Protection class	IP 67
Protection degree	III, operation on protective low voltage
Casing material	Aluminium anodized
Material	PVC (Cable)
Connection	Cable, 5,0 m