

IRD 50 NSOK-IBS

Inductive Ring Sensor

- High resolution
- Short response time
- Sensitivity and pulse stretching adjustable
- Insensitive to dirt
- Dynamic operating principle
- Metal connector
- High protection class

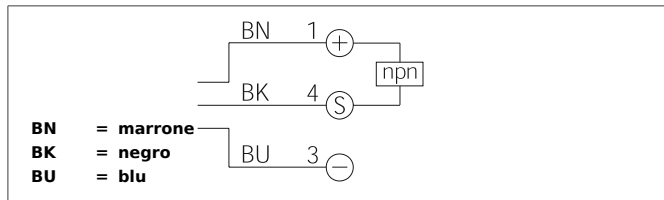
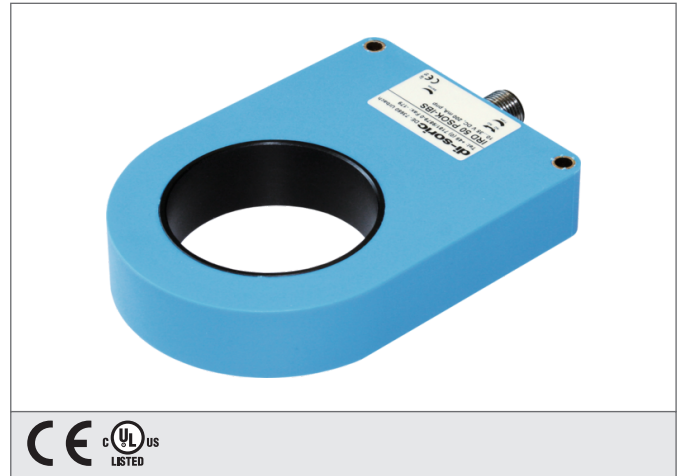

Safety instructions

The Instruments are not to be used for safety applications, in particular applications in which safety of persons depends on proper operation of the instruments.

These instruments shall exclusively be used by qualified personnel.

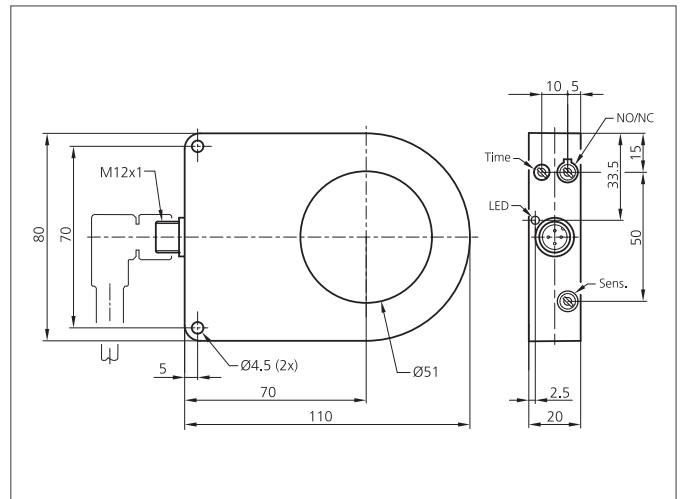

TECHNICAL INFORMATION (typ.)		+20°C, 24V DC
Operating principle		Dynamic
Inside diameter		51 mm
Service voltage		10 ... 35 V DC (Supply Class 2)
No-load current		< 11 mA
Resolution		Ø 3,0 mm
Sensitivity adjustment		potentiometer
Mounting distance to metal		> 10 mm
Switching output		npn, 200 mA, NO/NC, switchable
Shock-/vibration load		10 ... 55 Hz / 1,0 mm / 30 g
Speed of parts		< 25 m/s
Minimum parts speed		0,1 m/s
Pulse stretching		0,1 ... 150 ms adjustable
Voltage drop		< 2,0 V
Response-/release time		0,20 ms / 0,20 ms
Ambient temperature, operation		-25 ... +70 °C
Insulation voltage endurance		1.000 V
Protection class		IP 67
Protection degree		III, operation on protective low voltage
Casing material		polyamide / ring POM
Connection		Connector, M12, 4-poled
Connecting cable		VK ...