

MZ-K-11/6.5 Sensor bracket

- Reliable mounting of cylinder sensors at profiled cylinders
- High locking power
- Robust metal casing
- For a quick and easy fix and mounting of sensors

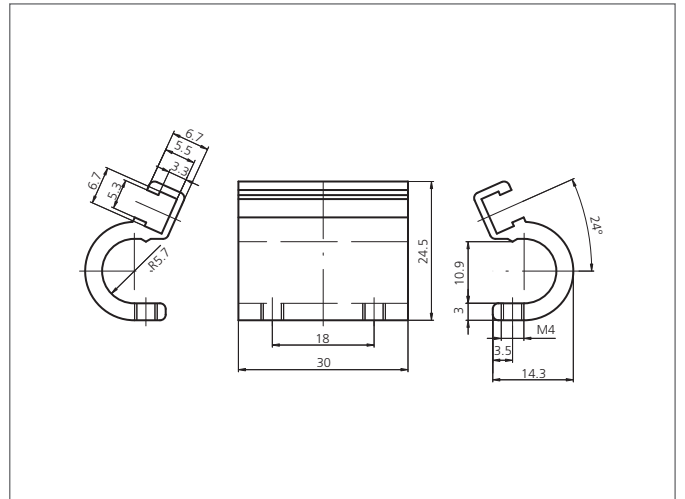
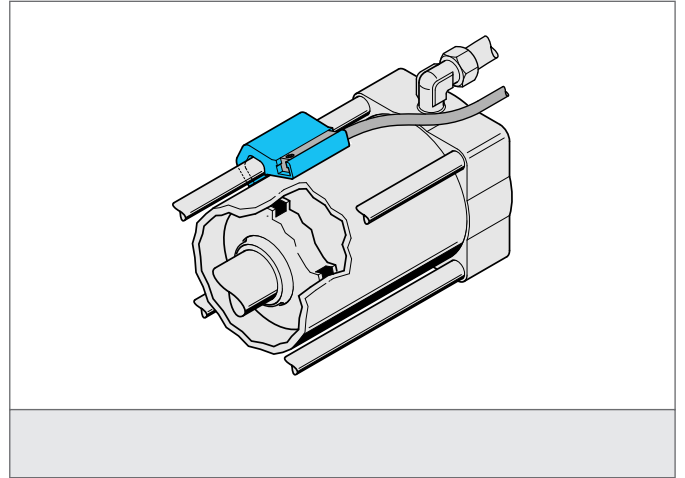

TECHNICAL INFORMATION (typ.)

Mounting	at profiled cylinders
Suitable for	Cylinder sensores with T-Slot
Casing material	Aluminium
Application	Piston Ø 32-40 mm
Scope of delivery	Fixing material