

BEK-P14-G7T-IBS

Spotlight

- Constant level of light intensity over the entire voltage range
- Homogenous luminous field
- External trigger input
- Internal control of power output
- High efficiency
- Low levels of heat produced
- Robust metal casing

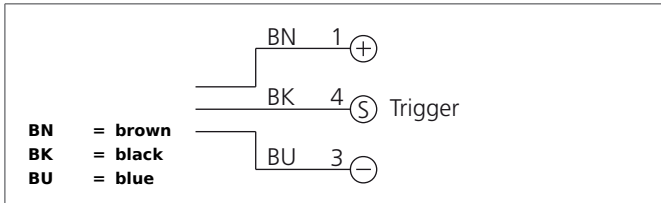

Safety instructions

ATTENTION: Exposure can lead to eye and skin irritation. Use suitable protection shield. Pay attention to accident prevention rules and risk group DIN EN 62471. These instruments shall exclusively be used by qualified personnel.

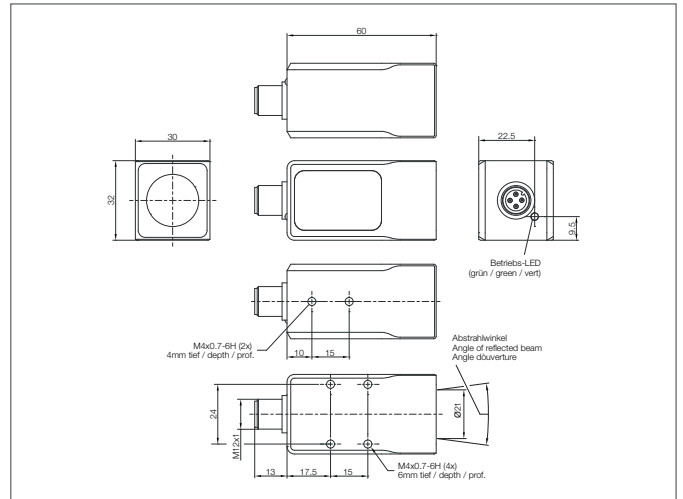

TECHNICAL INFORMATION (typ.)	+20°C
Size	30 x 32 x 60 mm (Dimensions)
Characteristics	Internal control of power output, Trigger input
Light colour	UV, 365 nm
Emission angle FWHM	14°
Service voltage	18 ... 30 V DC (Supply Class 2)
No-load current	150 mA, (24 V DC)
Light outlet	axial
Trigger input low level	0 ... < 2,8 V
Trigger input high level	> 3,4 ... 30 V
Power	3,6 W (18...30 V DC)
Inverse polarity protection	Yes
Display	LED: green - Operation
Ambient temperature, operation	0 ... +40 °C
Protection class	IP 67
Protection degree	III, operation on protective low voltage
Casing material	Aluminium black anodized
Material	glass (Window)
Connection	Connector, M12, 4-poled
Weight	114 g
Connecting cable	VK ...