

BEK-P14-G5T-IBS

Spotlight

- Constant level of light intensity over the entire voltage range
- Homogenous luminous field
- External trigger input
- Internal control of power output
- High efficiency
- Low levels of heat produced
- Robust metal casing

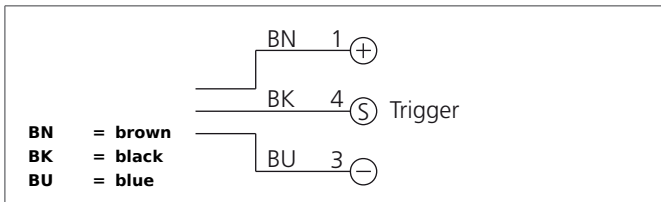

Safety instructions

The Instruments are not to be used for safety applications, in particular applications in which safety of persons depends on proper operation of the instruments.

These instruments shall exclusively be used by qualified personnel.

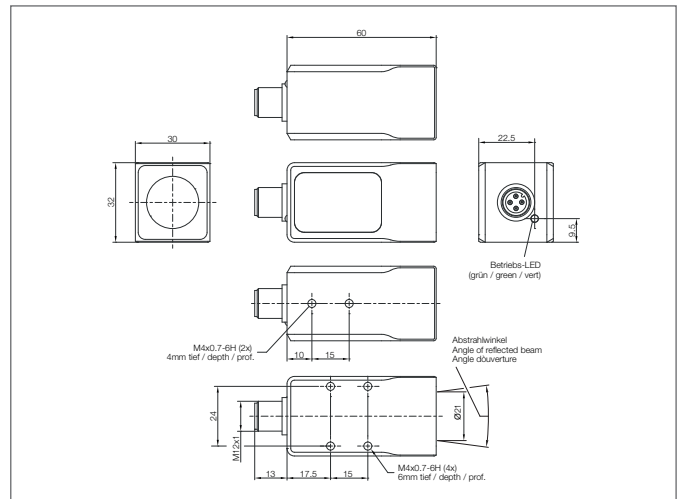

TECHNICAL INFORMATION (typ.)	+20°C
Size	30 x 32 x 60 mm (Dimensions)
Characteristics	Internal control of power output, Trigger input
Light colour	White, 6500 K
Emission angle FWHM	14°
Service voltage	18 ... 30 V DC (Supply Class 2)
No-load current	145 mA, (24 V DC)
Light outlet	axial
Trigger input low level	0 ... < 2,8 V
Trigger input high level	> 3,4 ... 30 V
Power	3,5 W (18...30 V DC)
Inverse polarity protection	Yes
Display	LED: green - Operation
Ambient temperature, operation	0 ... +40 °C
Protection class	IP 67
Protection degree	III, operation on protective low voltage
Casing material	Aluminium black anodized
Material	polymethyl methacrylate (Window)
Connection	Connector, M12, 4-poled
Weight	110 g
Connecting cable	VK ...